

# NEW JAGUAR F-TYPE



THE ART OF PERFORMANCE





BY APPOINTMENT TO  
HM THE QUEEN  
MANUFACTURERS OF  
MOTOR VEHICLES  
JAGUAR LAND ROVER LIMITED  
COVENTRY



BY APPOINTMENT TO  
HRH THE DUKE OF EDINBURGH  
MANUFACTURERS OF  
MOTOR VEHICLES  
JAGUAR LAND ROVER LIMITED  
COVENTRY



BY APPOINTMENT TO  
HRH THE PRINCE OF WALES  
MANUFACTURERS OF  
MOTOR VEHICLES  
JAGUAR LAND ROVER LIMITED  
COVENTRY



## JAGUAR

# THE ART OF PERFORMANCE

Every day we push performance to its limit. Our performance. Our cars' performance.  
We innovate, we engineer, we design. We master rules and then break them.  
Only to push further. Past the limits of convention. This is when performance becomes art.

Jaguar. The Art of Performance.



## CONTENTS

### INTRODUCTION

The Concept of F-TYPE	06
F-TYPE - The Facts	08

### DESIGN

Exterior Principles	10
Exterior Detail	12
LED Headlights	14
Interior Connection	16
An Exclusive Space	18
Lightweight Seats	20
Luggage Space	22

### PERFORMANCE

Engines Overview	24
V6 Engines and V8 Engines	26
Lightweight Aluminium Architecture	28
Chassis and Suspension	30
Advanced Aerodynamics	32
Tested To The Extreme	34

### DRIVING TECHNOLOGY

Advanced Driving Dynamics	36
Dynamic Mode and Configurable Dynamics	38
Advanced Drivetrain Technology	40
Torque Vectoring	42
Stability and Control	44
Performance Braking Systems	46

### INCONTROL TECHNOLOGIES

Infotainment and Connectivity	48
Touch Pro and Connect Pro	50
Audio	52

### SAFETY

Advanced Driver Assistance	54
F-TYPE 400 SPORT Special Edition	56

### F-TYPE SVR

Special Vehicle Operations	58
The Concept of F-TYPE SVR	60
F-TYPE SVR Aerodynamics	62
F-TYPE SVR Lightweight Technologies	64
F-TYPE SVR Interior	66

### PERSONALISATION

F-TYPE - Your Choice	68
Choose your Engine	70
Choose your Model	72
Choose your Options	74
Choose your Colour	84
Choose your Wheels and Braking System	86
Choose your Interior	88
Choose your Jaguar Gear Accessories	102
Technical Specifications	106
Dimensions	108

### JAGUAR WORLD

Jaguar Experience	110
The World of Jaguar	112
Glossary and Legal Information	114



Scan to find out more about F-TYPE

VEHICLE SHOWN: F-TYPE R-DYNAMIC AWD IN SILICON SILVER WITH OPTIONAL FEATURES FITTED (MARKET DEPENDENT)

VEHICLES SHOWN ARE FROM THE JAGUAR GLOBAL RANGE. SPECIFICATIONS, OPTIONS AND AVAILABILITY WILL VARY BETWEEN MARKETS AND SHOULD BE VERIFIED WITH YOUR LOCAL JAGUAR RETAILER

## INTRODUCTION

# THE CONCEPT OF F-TYPE

The new Jaguar F-TYPE is the latest in a distinguished bloodline of powerful, agile and distinctive sports cars. Combining exhilarating performance, accomplished handling and cutting-edge technology, it delivers an exceptional driver-focused experience.

F-TYPE's latest enhancements ensure it remains as up-to-date as it is special. Jaguar's most advanced infotainment system, Touch Pro, is standard with a highly responsive 8" Touchscreen, improved navigation options and 10GB of personal media storage. Connect Pro\* offers enhanced connectivity and a range of InControl Apps to make journeys quicker and easier.

New LED headlights help drivers distinguish objects more clearly with a quality of beam that is closer to daylight. Exterior styling updates ensure F-TYPE is as striking as when it won 'Design of the Year' at the 2013 World Car Awards. Inside, new slim seats save weight and give more space and comfort, while new finishers on interior details allow even more personalisation. And now, the new F-TYPE 400 SPORT Special Edition features a 3.0 litre V6 engine with a unique 400PS tune and exclusive exterior and interior detailing.

F-TYPE is a truly cutting-edge expression of the Art of Performance.

\*Market dependent.

VEHICLE SHOWN: F-TYPE SVR IN CALDERA RED WITH OPTIONAL FEATURES FITTED (MARKET DEPENDENT)





## F-TYPE - THE FACTS

Stunning design, exhilarating performance, instant response, agile handling and advanced technology. F-TYPE is created to deliver breathtaking driving experiences.

### ALL WHEEL DRIVE

F-TYPE's All Wheel Drive (AWD) system combines the agility and character of Rear Wheel Drive (RWD) with the increased security and traction provided by AWD. In normal driving, F-TYPE is predominantly RWD to deliver handling purity, feel and balance. But when needed the system rapidly redistributes torque to the front axle, enabling F-TYPE to maintain optimum traction in all conditions.

### TECHNOLOGY

F-TYPE's advanced technologies keep you safe, entertained and connected. Available for the first time on F-TYPE, Park Assist makes parking in tight spaces easier than ever. Our next-generation Touch Pro infotainment system, with its tablet-style Touchscreen, puts a world of entertainment and 4G Internet connection at your fingertips. The system offers intuitive swipe and pinch-to-zoom navigation, personal media storage and, with Protect, the option to remotely connect and monitor F-TYPE wherever you are in the world.

### JAGUAR CARE\* - TOTAL COST OF OWNERSHIP

F-TYPE is offered with an unlimited mileage, three year warranty and three years' servicing programme. We call this programme Jaguar Care. It makes F-TYPE's overall cost of ownership one of the lowest in its class.



### INTERIOR

Luxury and driver focus find their balance in F-TYPE. New slimline seats with a lightweight magnesium construction offer improved lateral support and save over 8kg<sup>†</sup> of weight compared with previous generation models. With a redesigned steering wheel, plus the availability of a sporty Siena Tan interior, F-TYPE looks just as distinctive on the inside as it does on the outside.

\*Available in selected European markets only. \*\*Optional on F-TYPE. Standard on F-TYPE R-Dynamic, F-TYPE R and F-TYPE SVR. †Comparative weight saving for Performance seats. ††Engine dependent. ‡Only available on F-TYPE R and F-TYPE SVR.

VEHICLE SHOWN: F-TYPE R IN YULONG WHITE WITH OPTIONAL FEATURES FITTED (MARKET DEPENDENT)



## DESIGN

F-TYPE's remodelled front end features a redesigned bumper framed by new LED headlights\*\*. These elegant headlights adapt the width and depth of their beam to your speed and offer a superb quality of light - so you always have the best possible illumination whatever your surroundings.

## SUPERCHARGED PERFORMANCE

All F-TYPE engines use a twin vortex supercharger to eliminate acceleration lag. Throttle response is instantaneous with seamless power delivery and high levels of torque at all engine speeds. The latest engine to use this technology is the V8 unit found in F-TYPE SVR, which makes it Jaguar's most powerful production car ever.



## HANDLING AND AGILITY

To optimise F-TYPE's handling and agility, a range of driving technologies are available. These include Torque Vectoring, Adaptive Dynamics\*\* and an Electronic Active Differential†. Each one works to enhance the driving experience through increased control, traction and feel.





## DESIGN EXTERIOR PRINCIPLES

### DRAMATIC DESIGN

"A piece of design should tell a story. F-TYPE's lines have a start, a direction and a conclusion. Make every line individual and aesthetically correct, with the right dimensions, and a design will stand the test of time."

#### **Ian Callum, Jaguar Design Director**

Those bold proportions. Those instinctive curves. Timeless, evocative and progressive in a way that could only be Jaguar.

Some say great design is subjective, but for us there's no debate: F-TYPE's beauty is the ultimate expression of the Art of Performance.

VEHICLE SHOWN: F-TYPE R-DYNAMIC AWD IN SILICON SILVER WITH OPTIONAL FEATURES FITTED (MARKET DEPENDENT)



## EXTERIOR DETAIL

### POWERFUL FORM

Rising vertically from the front spoiler and running up through elongated headlights, F-TYPE's beautifully flowing body line begins to take shape. The line arcs over the front wheel, descending elegantly as it runs across the door, before culminating in a pronounced muscular rear haunch. Whether you choose Coupé or Convertible, F-TYPE leaves you under no illusion - this is a high performance sports car, the latest in a distinguished bloodline.

VEHICLE SHOWN (LEFT): F-TYPE R-DYNAMIC AWD IN SILICON SILVER WITH OPTIONAL FEATURES FITTED (MARKET DEPENDENT)  
VEHICLE SHOWN (RIGHT): F-TYPE IN INDUS SILVER WITH OPTIONAL FEATURES FITTED (MARKET DEPENDENT)



It is, in part, sculpted by the wind itself, formed by Jaguar's state-of-the-art Computational Fluid Dynamics design methods. A front splitter beneath the grille and rear venturi manage airflow along the underside, while a deployable rear spoiler\* automatically rises at higher speeds to increase downforce and reduce drag. Even the door handles retract when not required, their flush design creating an uninterrupted airflow along F-TYPE's flanks.

\*Optional on F-TYPE SVR.

# LED HEADLIGHTS



SIGNATURE DESIGN

ENHANCED ILLUMINATION



Even at night, F-TYPE stands out. Its new LED headlights\* featuring LED 'J' blade Daytime Running Lights are as powerful as they look. These headlights reach further into the darkness than previous generation units, producing a highly focused beam of light with a quality closer to daylight, helping your eyes distinguish objects more easily and reducing fatigue.

Optional Auto High Beam Assist provides added safety and convenience by automatically dipping the beam when other vehicles are detected. 'J' blades complete the dramatic headlight design. These crisp bars of light wrap round each light's outer edge, giving F-TYPE an instantly recognisable visual signature that adds to its assertive presence and distinctive style.

\*Optional on F-TYPE. Standard on F-TYPE R-Dynamic, F-TYPE R and F-TYPE SVR.

VEHICLE SHOWN: F-TYPE R-DYNAMIC AWD IN SILICON SILVER WITH OPTIONAL FEATURES FITTED (MARKET DEPENDENT)



LED headlights feature Adaptive Front Lighting. It automatically provides the best possible illumination by adjusting the low beam according to your speed and the weather conditions.

**City Mode**

A wider beam than a standard low beam to help you see pedestrians and turnings more easily in built-up areas.

**Country Mode**

A low beam that is narrowed and extended, in comparison to City Mode, to offer better illumination for country driving.

**Motorway Mode**

A longer and narrower beam than Country Mode to improve long range visibility. The low beam is raised to extend illumination further down the road.

**Bad Weather Mode**

Adjusts the intensity of the low beam to minimise glare from reflections while still offering strong illumination of the road ahead. It is only activated when the windscreen wipers are in continuous operation.





# INTERIOR CONNECTION



**DRIVER FOCUS**

**CLARITY OF DESIGN**

In F-TYPE you and the car become one. Every aspect of its 1+1 configuration is designed to create a bond. It wraps around you, taking your driving experience to greater heights.

The cockpit provides maximum visibility, minimal distractions and close-to-the-centre-of-gravity seating for a complete connection with the car. The low fascia is free from clutter to increase the view ahead.

The active central air vent, part of the advanced climate control system, hides the twin central air vents, which automatically rise from the dashboard as required and retract after use.

F-TYPE's easy to use 8" colour Touchscreen is your primary interaction point with the Touch Pro infotainment system. The system responds directly to touch and swipe gestures, providing effortless control over navigation, music, phone, climate and driver assistance features.

VEHICLE SHOWN: F-TYPE R-DYNAMIC AWD FEATURING EBONY PREMIUM LEATHER PERFORMANCE SEATS WITH IVORY CONTRAST STITCH WITH OPTIONAL FEATURES FITTED (MARKET DEPENDENT)





## AN EXCLUSIVE SPACE



SUPERIOR CRAFTSMANSHIP

A TAILORED SPACE

We design our interiors so that nothing detracts from the outstanding driving experience. You'll always feel comfortably cocooned in F-TYPE's exquisitely crafted cockpit. The cabin's styling has been subtly refreshed to enhance refinement while maintaining driver focus. Every element of the interior has been reappraised, with updates to even the smallest details, such as the Chrome finishes on the doors and steering wheel, deepening the sense of luxury.

Every F-TYPE's interior starts with Jaguar's quintessential British character, but its unique personality is up to you. Tailor your interior styling with a variety of stitches and materials including premium leather and suedecloth, as well as Ebony, Pimento, Ivory and Siena Tan colour combinations. It's easy to make F-TYPE feel truly personal, to make F-TYPE your perfect sports car.

VEHICLE SHOWN: F-TYPE R-DYNAMIC AWD FEATURING EBONY PREMIUM LEATHER PERFORMANCE SEATS WITH IVORY CONTRAST STITCH WITH OPTIONAL FEATURES FITTED (MARKET DEPENDENT)



## LIGHTWEIGHT SEATS



WEIGHT SAVING

COMFORT AND SUPPORT

F-TYPE's new Sport and Performance seats have been engineered with sports cars in mind. The lighter magnesium construction of the seats saves over 8kg\* of weight compared with previous generation models. Their streamlined form takes up less space enabling a greater range of seating positions. Performance seats provide increased lateral support during dynamic driving and the option of cooling for greater comfort.

\*Comparative weight saving for Performance seats. Sport seats are standard on F-TYPE and F-TYPE R Dynamic. Performance seats are standard on F-TYPE R and F-TYPE SVR and optional on F-TYPE and F-TYPE R-Dynamic.

VEHICLE SHOWN ABOVE AND RIGHT: F-TYPE R-DYNAMIC AWD FEATURING EBONY PREMIUM LEATHER PERFORMANCE SEATS WITH IVORY CONTRAST STITCH WITH OPTIONAL FEATURES FITTED (MARKET DEPENDENT)







## LUGGAGE SPACE

 408 LITRES | OPTIONAL POWERED TAILGATE\*

We have designed the loadspace of F-TYPE Coupé to create a sports car that fits every lifestyle. With a capacity that is competitive with some well-known family hatchbacks – up to 408 litres (and 207 litres in F-TYPE Convertible) – F-TYPE Coupé certainly has the space to accommodate two generously sized suitcases for a weekend away. For added ease of access, the tailgate can be opened or closed at the touch of a button with the optional powered function.

\*Coupé only.

VEHICLES SHOWN: F-TYPE IN INDUS SILVER AND F-TYPE R-DYNAMIC AWD IN SILICON SILVER WITH OPTIONAL FEATURES FITTED (MARKET DEPENDENT)

# PERFORMANCE ENGINES OVERVIEW



**SUPERCHARGED ENGINES**

**RESPONSIVE POWER**

F-TYPE's beating heart is supercharged – delivering high levels of torque at all engine speeds and a near instantaneous response to your demand for power. Choose from four highly advanced engines: a 3.0 litre V6 340PS, a 3.0 litre V6 380PS, a 5.0 litre V8 550PS and a 5.0 litre V8 575PS.

Every F-TYPE is fitted with an Active Sports Exhaust that creates a race-car inspired crescendo. The exhaust system reacts to throttle position, speed and engine revs by opening active valves. When open, these valves allow exhaust gases to take a more direct, less restrictive route through the rear silencer producing a much richer, more exhilarating sound. The Switchable Active Exhaust\* allows you to manually open the exhaust valves so you can enjoy F-TYPE's stirring soundtrack at all engine speeds.

To improve fuel economy, particularly during urban driving, a fast-reacting Intelligent Stop/Start system is fitted to every F-TYPE as standard\*\*.

## V6 ENGINES

## CENTRE MOUNTED TWIN EXHAUSTS

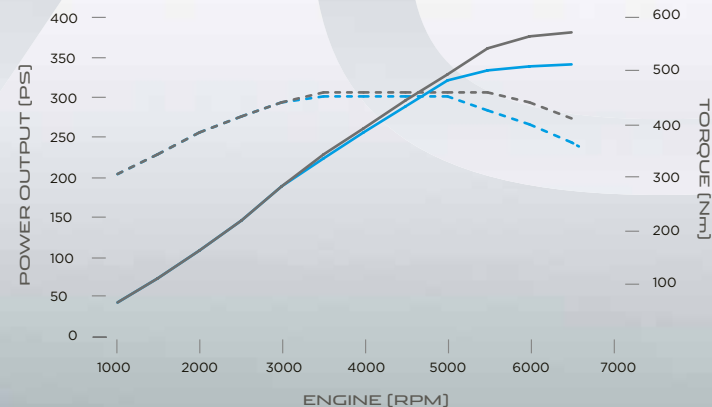

\*Optional on F-TYPE, standard on F-TYPE R-Dynamic, F-TYPE R and F-TYPE SVR. \*\*Market dependent.

VEHICLES SHOWN: F-TYPE IN YULONG WHITE WITH OPTIONAL FEATURES FITTED (MARKET DEPENDENT)

POWER [PS]      340PS      380PS  
 TORQUE [Nm]      - - - - -      - - - - -



# V8

V8 ENGINES

OUTBOARD MOUNTED QUAD EXHAUSTS

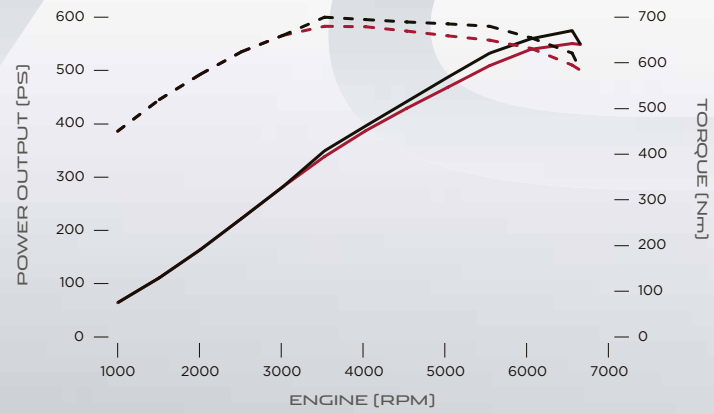

VEHICLES SHOWN: F-TYPE R IN YULONG WHITE WITH OPTIONAL FEATURES FITTED (MARKET DEPENDENT)

POWER [PS]      550PS      575PS  
 TORQUE [Nm]      - - - - -      - - - - -

# V6 ENGINES



3.0 LITRE V6 340PS

3.0 LITRE V6 380PS

The 3.0 litre V6 Supercharged engines balance immediate responsiveness with refined power delivery, giving strong, linear acceleration all the way to the redline. At their core, a lightweight aluminium die-cast block is reinforced with cross-bolted main bearing caps to increase rigidity and refinement. A single balancer shaft and innovative counter-rotating front and rear balancer weights further smooth performance.

Aluminium is also used for the four-valve cylinders, with the valves themselves controlled by dual independent variable cam timing. This timing optimises power, torque and economy while giving these engines their urgent and responsive character. To extract more energy from the fuel, giving better fuel economy and high specific power outputs, a spray guided direct injection system carefully manages the air-fuel mixture in the combustion chamber. Mounted in the 'V' between the two banks of cylinders, a compact, twin vortex supercharger uses sophisticated, electronically supervised boost control for efficiency and lag-free bursts of power. Optimising power and efficiency even further, a water intercooler reduces the temperature of the intake air into the supercharger.



## V6 ENGINES

# 0-100km/h from 4.9 seconds

3.0 LITRE V6 SUPERCHARGED		340PS	380PS	
Model availability		F-TYPE and F-TYPE R-DYNAMIC		
Cylinders/Valves per Cylinder		6/4	6/4	
Bore/Stroke		mm	84.5/89	84.5/89
Capacity		cc	2,995	2,995
Maximum Power		EEC-PS (kW)	340 (250)	380 (280)
Maximum Torque		EEC-Nm (lb. ft.)	450 (332)	460 (339)
Compression		ratio:1	10.5	10.5

Official EU test figures for comparison purposes only. Real world figures may differ.

# V8 ENGINES



5.0 LITRE V8 550PS

5.0 LITRE V8 575PS

The higher capacity 5.0 litre V8 Supercharged engines maximise their greater displacement – offering immense power with high torque for dynamic responsiveness and effortless acceleration. Sharing the same all-aluminium foundations as the 3.0 litre V6 engines, the V8 engines' blocks are stiffened with cast-iron liners and cross-bolted main bearing caps for increased rigidity and refinement. The V8s also use dual independent variable cam timing and a single balancer shaft with innovative counter-rotating front and rear balancer weights for the smooth delivery of optimal power.

A centrally mounted, multi-hole, high pressure direct injection system sprays precisely measured quantities of fuel directly into the centre of the combustion chambers to ensure uninterrupted power delivery and efficient fuel consumption. The Roots-type twin vortex supercharger features sophisticated boost control and a secondary throttle valve. It ensures that torque curves rise steeply over a broad range of engine speeds, guaranteeing linear power delivery. In both V8 engines, the supercharger is fed by two intercoolers featuring their own water-cooling circuit to reduce the temperature of the pressurised air, meaning more air can reach the engine, optimising combustion and therefore power output.



## V8 ENGINES

# 0-100km/h from 3.7 seconds

5.0 LITRE V8 SUPERCHARGED		550PS	575PS
Model availability		F-TYPE R	F-TYPE SVR
Cylinders/Valves per Cylinder		8/4	8/4
Bore/Stroke	mm	92.5/93	92.5/93
Capacity	cc	5,000	5,000
Maximum Power	EEC-PS (kW)	550 (405)	575 (423)
Maximum Torque	EEC-Nm (lb. ft.)	680 (502)	700 (516)
Compression	ratio:1	9.5	9.5

# LIGHTWEIGHT ALUMINIUM ARCHITECTURE



STRONG AND RIGID

HIGH POWER-TO-WEIGHT AND TORQUE-TO-WEIGHT RATIOS



A lightweight aluminium body with a strong, stiff structure is the perfect platform for a sports car. We pioneered this technology over a decade ago and continue to push the boundaries today. It informs every aspect of how F-TYPE performs, handles and feels. A strong, stiff structure provides an inherently stable platform for precise, agile handling and allows the finely-tuned suspension system to deliver connectivity and driver feedback. Lightweight aluminium panels are bonded together with a super-strong adhesive, then punched with zinc-coated, boron steel rivets that compress the adhesive to form an airtight bond for phenomenal strength and rigidity. F-TYPE's body is the perfect complement to its high-performance engine range. Together they produce the exceptional power-to-weight and torque-to-weight ratios that deliver the real world measures of performance in a sports car.

The exterior panels are made from specially developed alloys. They combine robustness with greater formability, which gives clarity and tightness to curves and feature lines. On Coupé models, the side pressing is one of the most technically advanced in the automotive industry. It allows for cleaner lines with an extraordinarily beautiful, uninterrupted sweep from the front pillar to the trailing edge. This combination of advanced materials and innovative techniques has two advantages. It allows us to reproduce F-TYPE's crisp, crafted lines exactly as the designers intended. And it delivers a vehicle with extraordinary structural integrity.

VEHICLE SHOWN: F-TYPE IN INDUS SILVER WITH OPTIONAL FEATURES FITTED (MARKET DEPENDENT)



F-TYPE

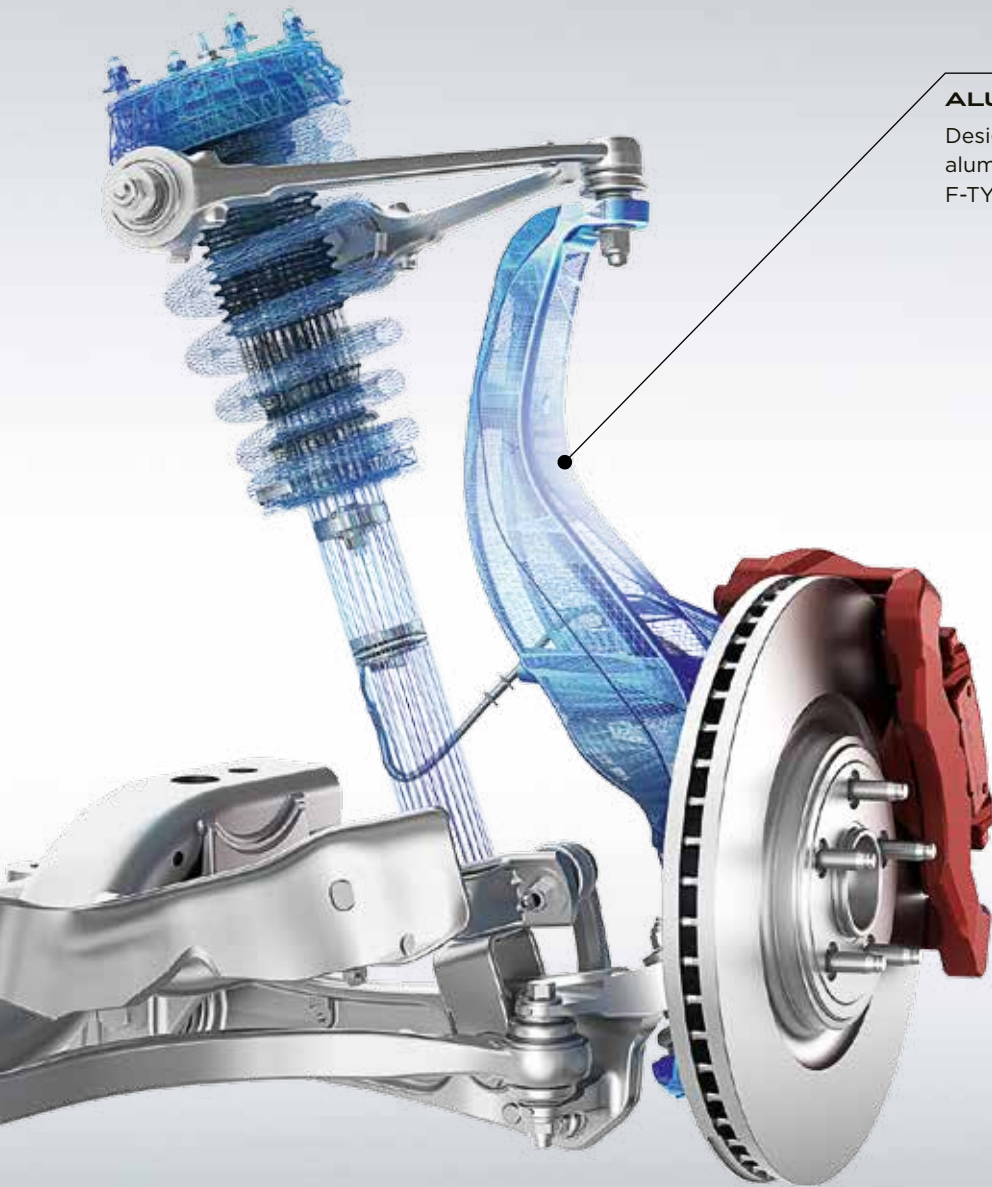

#### **ALUMINIUM SUSPENSION KNUCKLES**

Designed to optimise stiffness and strength, the lightweight aluminium front and rear suspension knuckles help improve F-TYPE's agility and responsiveness.

## **CHASSIS AND SUSPENSION**

**> CONTROL AND COMFORT** | **DYNAMIC AND REFINED**

F-TYPE's Lightweight Aluminium Architecture creates an immensely stable platform from which the forged aluminium double wishbone suspension can control the car. With the damping set-up optimised for the best partnership between dynamics and refinement, it gives the perfect combination of control, agility and feedback.

### ADAPTIVE DYNAMICS

Standard on the 3.0 litre V6 380PS and 5.0 litre V8 engines, Adaptive Dynamics delivers both composed dynamics and a compliant ride. The system assesses body motion and pitch rates 100 times per second. The steering wheel position is also measured 500 times a second enabling the system to predict F-TYPE's movements. The stiffness of each damper is then adjusted to maintain body control and agility.

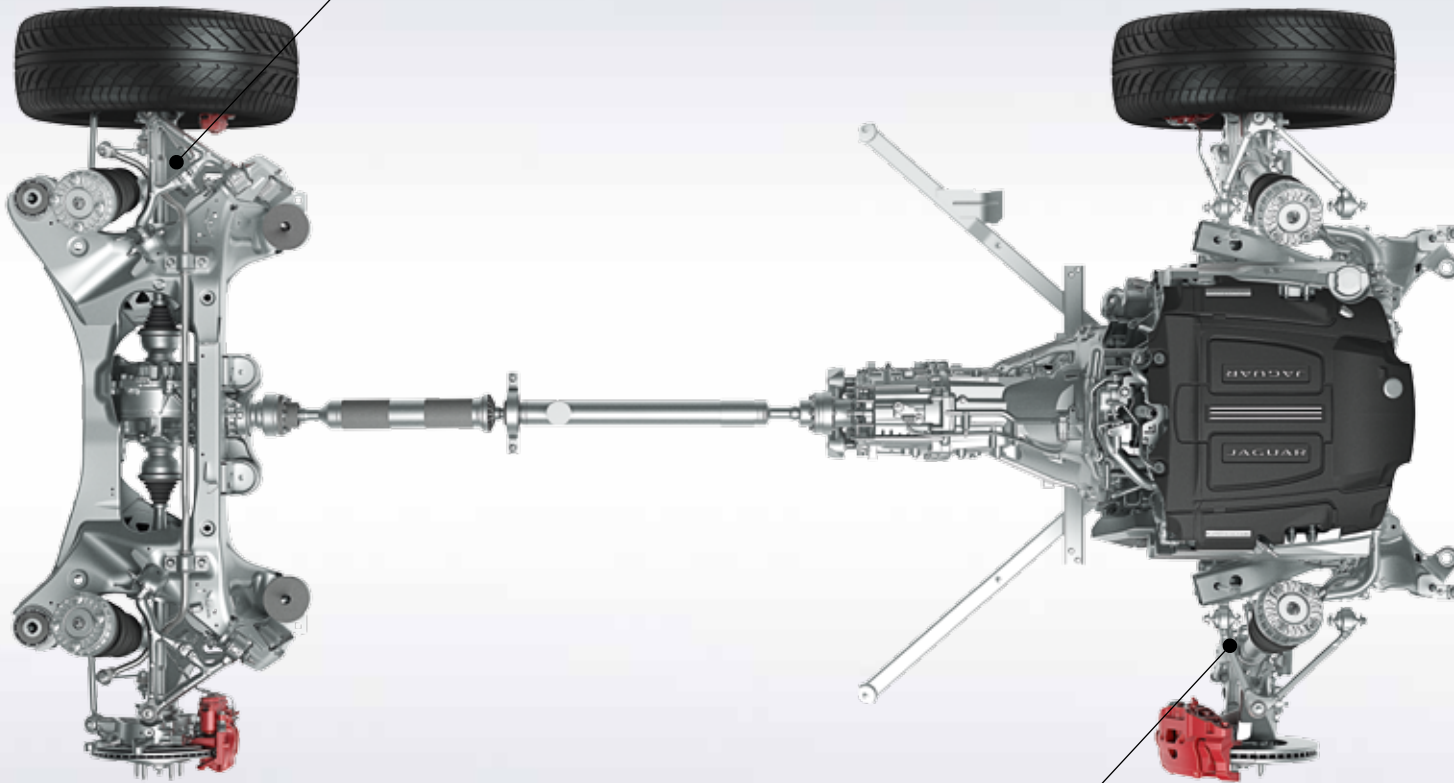

### SUSPENSION

Considered by Jaguar as the best configuration for a suspension system, F-TYPE's forged aluminium double wishbone design offers precise handling and control.

## ADVANCED AERODYNAMICS



LOW DRAG AND HIGH STABILITY

DEPLOYABLE REAR SPOILER

Aerodynamic performance is at the heart of F-TYPE's design. It is seamlessly integrated into the body for low levels of lift and excellent stability at high speed. Even the door handles retract to create an uninterrupted airflow along its flanks. The deployable rear spoiler\* automatically rises at higher speeds to reduce lift by up to 120kg. A front splitter beneath the grille manages airflow along the vehicle's underside, with the sharply defined tail helping to separate air cleanly at lower speeds. The result is improved handling and stability.

\*Optional on F-TYPE SVR.

VEHICLE SHOWN: F-TYPE R IN YULONG WHITE WITH OPTIONAL FEATURES FITTED (MARKET DEPENDENT)





**1,413 LITRES**

OF RECYCLED WATER PER MINUTE  
BLASTED AT EVERY CAR TO ENSURE F-TYPE  
IS MONSOON PROOF

**10,000,000 HOURS**

OF VIRTUAL TESTING, REDUCING OUR IMPACT ON THE  
ENVIRONMENT WITH SIGNIFICANT SAVINGS IN RESOURCE,  
WASTE, POWER AND FUEL

**792,000**

VIRTUAL VEHICLES CREATED  
TO PERFECT F-TYPE

**12,000 MILES**

OF EXTREME TRACK TESTING ON GERMANY'S  
INFAMOUS NÜRBURGRING RACE TRACK -  
EQUIVALENT TO DRIVING HALF WAY AROUND THE WORLD



90°C

DIFFERENCE BETWEEN F-TYPE'S HOTTEST  
(+50°C) AND COLDEST (-40°C) EXTREME CLIMATE  
TESTING ENVIRONMENTS

300 TERABYTES

OF PERFORMANCE DATA GATHERED TO REFINE  
EVERY MILLIMETRE OF F-TYPE

## TESTED TO THE EXTREME



VIRTUAL ANALYSIS

REAL WORLD TRIALS

F-TYPE first took to the road in the virtual world of Jaguar's Computer Aided Engineering (CAE) systems ensuring that all components underwent extensive development and testing before being committed to the physical testing process. Engineers produced a series of virtual prototypes to realistically simulate the behaviour of complex mechanical systems allowing them to analyse multiple variations until the optimum design was achieved. For example, using a technique first used in the aerospace industry, aerodynamic testing took place in a virtual wind tunnel with Computational Fluid Dynamics running on high speed supercomputers. During its virtual life, F-TYPE completed half a million analyses, requiring 10 million computer processor hours and creating 300TB of data. The CAE development process was one of the key contributing factors in delivering F-TYPE's exhilarating performance and responsiveness.

The real world testing to fine tune the set-up took place in specialist facilities and the harshest environments across the globe in temperatures ranging from -40°C to +50°C, and at altitudes of up to 4,000m. High-speed stability tests, for example, were conducted at Nardò in southern Italy. The Nordschleife circuit at the Nürburgring in Germany was the perfect location to prove out handling, braking, cooling and durability. Known as the "Green Hell", and featuring 20.8 kilometres of track with 73 turns, it is renowned as the most demanding circuit in the world and the ultimate test of both car and driver.

VEHICLE SHOWN: F-TYPE R IN YULONG WHITE WITH OPTIONAL FEATURES FITTED  
(MARKET DEPENDENT)

## DRIVING TECHNOLOGY ADVANCED DRIVING DYNAMICS



MAXIMISING AGILITY

CONTINUOUSLY ADAPTING

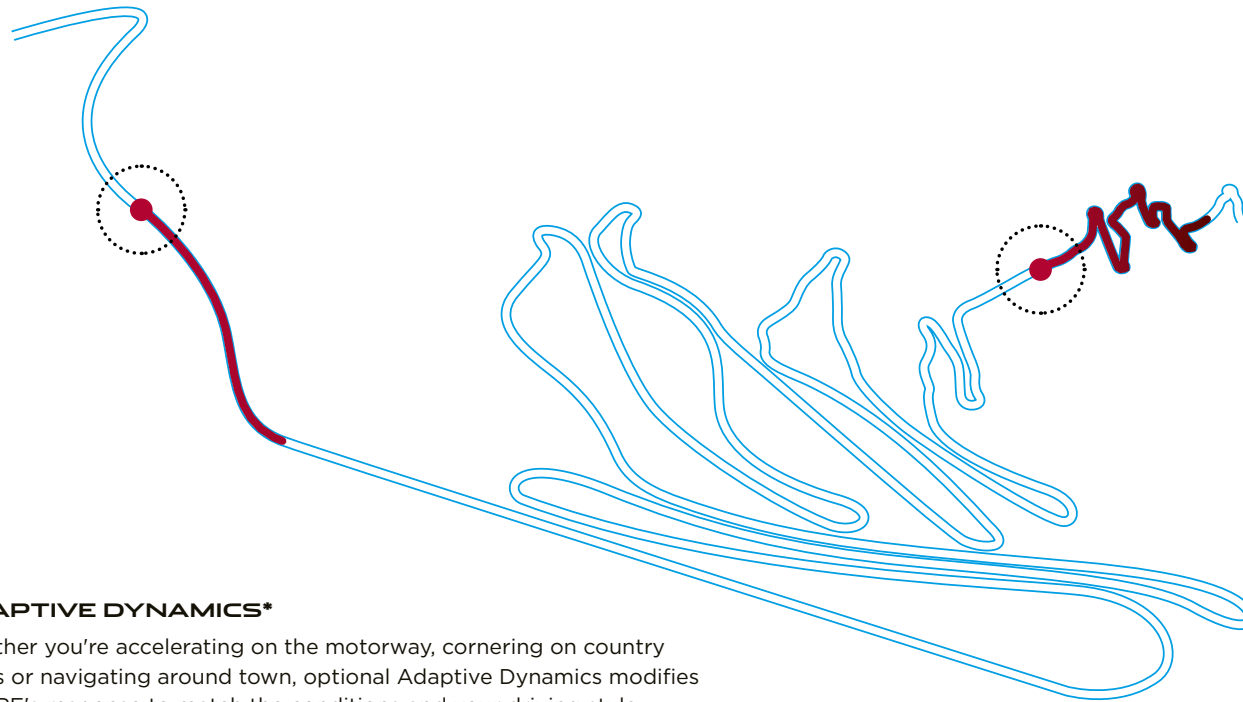

### ADAPTIVE DYNAMICS\*

Whether you're accelerating on the motorway, cornering on country roads or navigating around town, optional Adaptive Dynamics modifies F-TYPE's response to match the conditions and your driving style.

It analyses acceleration, cornering, throttle and brake pedal activity as well as kick-down activation. Steering movement is analysed up to 500 times a second, and body movement up to 100 times a second. Electronically controlled dampers then constantly adjust to optimise the suspension settings and maintain F-TYPE's dynamism and comfort.

### ELECTRIC POWER ASSISTED STEERING

Electric Power Assisted Steering (EPAS) offers outstanding feedback, control and is active on demand - saving power for where you really need it, as well as saving fuel. This steering system delivers the immediate response and connected feel expected from a Jaguar sports car. Sophisticated computer management varies steering assistance as appropriate - increasing assistance for low speed manoeuvring and improving feel at higher speeds.

\*Only available with the 3.0 litre V6 380PS engine and 5.0 litre V8 engines.



# INTENSIFIED PERFORMANCE



DYNAMIC MODE

CONFIGURABLE DYNAMICS



Engaging Dynamic Mode amplifies F-TYPE's sporting character. Gearshifts are faster and at higher engine speeds\* with automatic upshifts prevented if in Manual Mode, throttle response is sharpened, the dampers are stiffened\*\* and steering weighting is increased. Dynamic Mode also opens the Active Sports Exhaust for a more thrilling soundtrack and brings visual drama to the cabin - F-TYPE's instrument cluster and Configurable Interior Mood Lighting† instantly take on a red glow.

The Configurable Dynamics system\*\* allows you to personalise F-TYPE's Dynamic Mode to create your perfect dynamic setup. Via the Touchscreen, four driving characteristics can be changed to Dynamic or left as normal. So whatever combination of throttle sensitivity, gearbox shift points\*, steering weighting or damper stiffness you want, Configurable Dynamics allows you to set up Dynamic Mode to suit your driving needs.

\*Automatic transmissions only.

\*\*Not available with 3.0 litre 340PS engine.

†Standard on F-TYPE R and F-TYPE SVR. Optional on F-TYPE and F-TYPE R-Dynamic.



### DRY ROAD CONDITIONS

In normal conditions, torque is distributed to the rear wheels, delivering acclaimed Jaguar agility and handling.

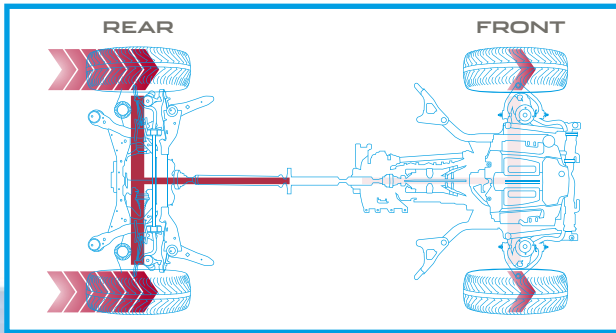

### LOW TRACTION CONDITIONS

On slippery surfaces, such as grass and snow, torque can be balanced between the front and rear wheels to maximise traction. In extreme conditions where only the front wheels have traction, up to 100 percent of engine torque can be distributed to the front wheels for optimum grip.

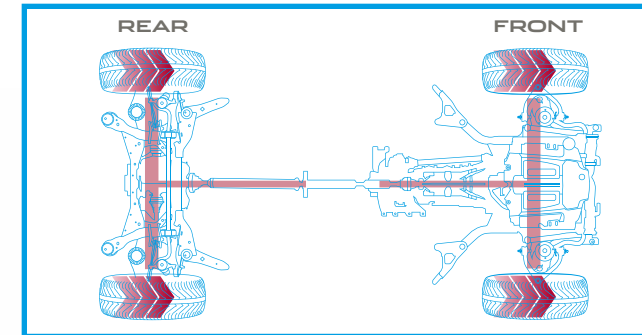



# ADVANCED DRIVETRAIN TECHNOLOGY



ALL WHEEL DRIVE

INTELLIGENT DRIVELINE DYNAMICS

F-TYPE's All Wheel Drive (AWD) system combines the agility and character of Rear Wheel Drive (RWD) with the increased security and traction provided by AWD. In normal driving, F-TYPE is predominantly RWD to deliver handling purity, feel and balance. But when roads become more challenging, or when you accelerate more keenly on low-grip surfaces, the system subtly channels power forwards enabling F-TYPE to maintain optimum traction for comfortable progress in all conditions.

F-TYPE's AWD uses a transfer case at the back of the 8-speed Automatic Transmission to manage the appropriate distribution of torque to the front and rear wheels. Engineered to ensure that F-TYPE retains the dynamic behaviour appropriate for a sports car, the transfer case contains an electro-mechanically activated multi-plate clutch with a smart actuator. Torque is delivered quickly and accurately, via a sophisticated ball ramp mechanism that develops the required force at the clutch, to transfer the optimal amount of torque to the front wheels.

Unlike other systems that react to wheel slip, Jaguar's Intelligent Driveline Dynamics (IDD) software is predictive and uses sensors measuring throttle and steering inputs to anticipate wheel slip. IDD seamlessly co-ordinates these inputs and compares them with responses from the engine, transmission and traction control systems to calculate the traction available and distribute torque accordingly, even before grip is lost. From a standstill, F-TYPE can transition from RWD to AWD in as little as 165 milliseconds, or just 100 milliseconds when the car is moving.

The result is a drive which blends the character of RWD with the capability of AWD, providing outstanding levels of performance and control whatever the road throws at you.

# TORQUE VECTORING



**INCREASED STEERING  
PERFORMANCE**

**ENHANCED  
CORNERING CAPABILITY**

F-TYPE's Torque Vectoring maximises capability through even the tightest corners. Torque Vectoring technology provides controlled independent braking of the individual, inside front and rear wheels to add to the turning forces acting on the car. In most conditions more braking pressure is applied to the rear inside wheel as this supports the most increased cornering capability, while the front inside wheel is braked for greater effectiveness and refinement. The result is reduced understeer for sharper turning and more consistent road holding.

Torque Vectoring delivers increased agility and added driver confidence. On F-TYPE R and F-TYPE SVR, Torque Vectoring works together with the Electronic Active Differential system (see page 44), complementing each other to optimise traction and cornering ability as well as maximising steering feel and agility.

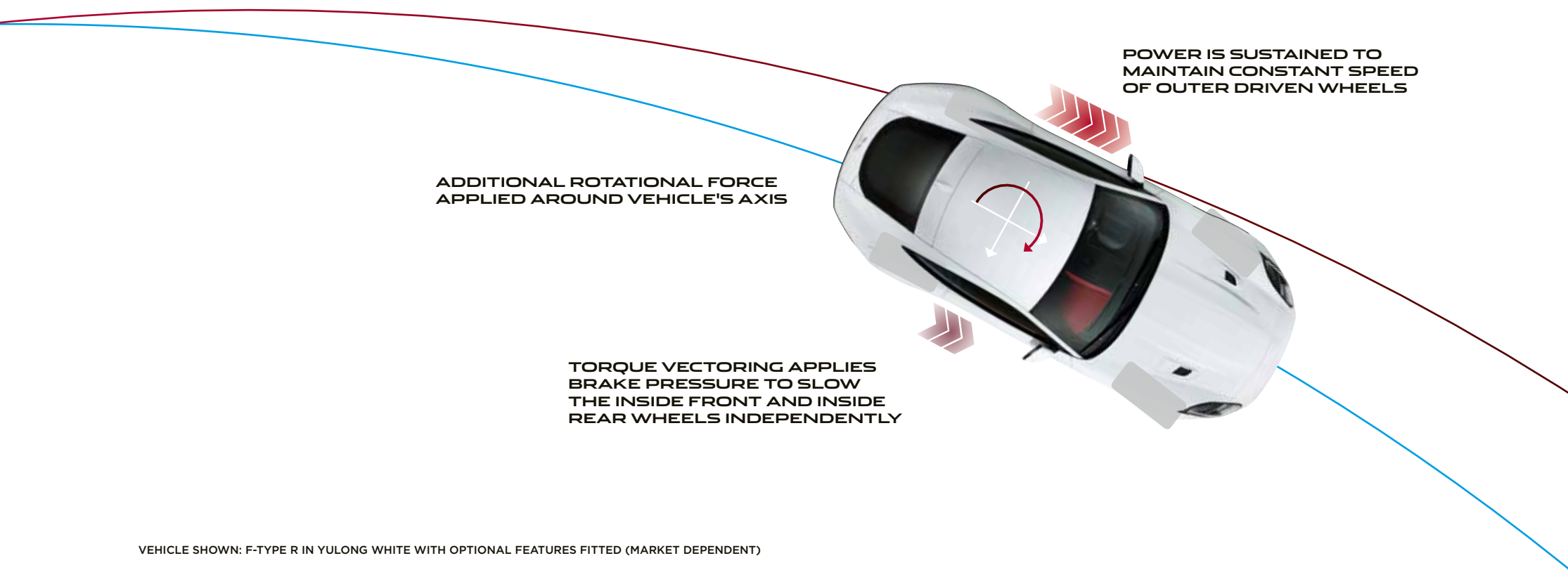

**ADDITIONAL ROTATIONAL FORCE  
APPLIED AROUND VEHICLE'S AXIS**

**TORQUE VECTORING APPLIES  
BRAKE PRESSURE TO SLOW  
THE INSIDE FRONT AND INSIDE  
REAR WHEELS INDEPENDENTLY**

**POWER IS SUSTAINED TO  
MAINTAIN CONSTANT SPEED  
OF OUTER DRIVEN WHEELS**

VEHICLE SHOWN: F-TYPE R IN YULONG WHITE WITH OPTIONAL FEATURES FITTED (MARKET DEPENDENT)



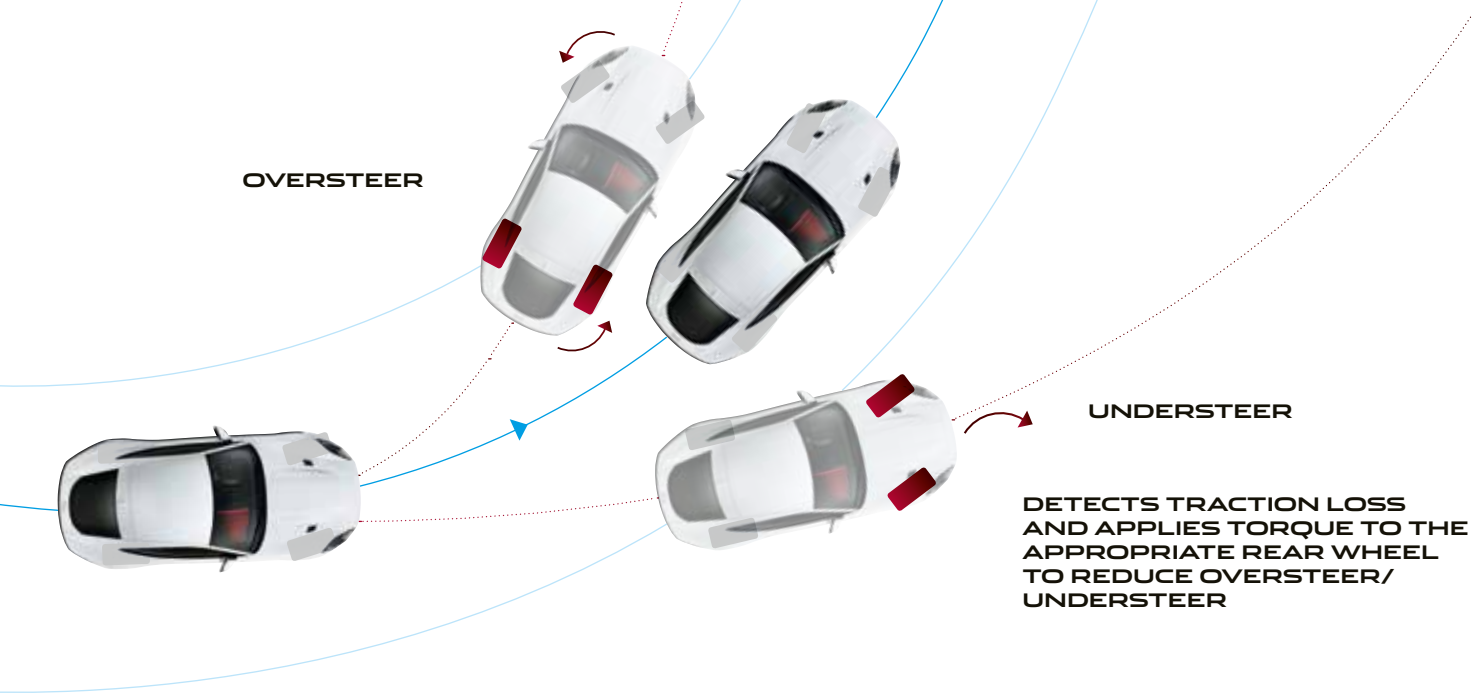

## STABILITY AND CONTROL

### > OUTSTANDING TRACTION | ELECTRONIC ACTIVE DIFFERENTIAL

Jaguar's stability systems keep F-TYPE well balanced whether you're driving enthusiastically or simply require the assurance of a car that will remain stable in challenging conditions. To fully harness their performance potential, and for greater control and traction, a Limited Slip Differential is fitted with the 3.0 litre V6 380PS engine and an Electronic Active Differential is fitted with the 5.0 litre V8 550PS and 575PS engines.

**Limited Slip Differential:** When a rear wheel has low grip, the Limited Slip Differential transfers torque through a mechanically activated clutch pack to the wheel that has more grip. This limits slip across the axle, improving control and traction for faster, more precise cornering.

**Electronic Active Differential:** Has a higher locking torque capacity to exploit the increased power and torque of the V8 engines. This differential works with the AWD system and Intelligent Driveline Dynamics (IDD) software, as well as F-TYPE's traction and stability systems, to maximise traction and improve cornering control. Variable electronic control allows this differential to continually adjust locking torque between the wheels – this gives sharper turn in when entering corners and the ability to accelerate sooner when leaving corners because the torque at each wheel is more controllable.

VEHICLE SHOWN: F-TYPE R IN YULONG WHITE WITH OPTIONAL FEATURES FITTED (MARKET DEPENDENT)





**JAGUAR**  
CARBON CERAMIC

# PERFORMANCE BRAKING SYSTEMS

**>** LIGHTWEIGHT | POWERFUL | DURABLE

A range of braking systems are available, each one engineered to deliver a confident, progressive feel and consistent high performance. The calipers use aluminium to reduce the unsprung mass of the car, benefiting both handling and ride refinement. Each system features large, ventilated brake discs – up to 398mm in diameter on the Carbon Ceramic system. This large swept area improves braking force as well as providing greater capacity for the discs to absorb and dissipate the heat energy generated during braking.

Jaguar's Carbon Ceramic Braking system, with its striking Yellow monobloc calipers is the most powerful braking system ever fitted to a Jaguar road car. It offers up to 21kg of weight saving, further reducing unsprung mass. With greater resistance to fade and wear, it delivers high levels of sustained performance in the most demanding conditions.

355MM FRONT AND  
325MM REAR BRAKES



CALIPERS: SILVER (STANDARD)  
STANDARD ON F-TYPE 340PS AND  
F-TYPE R-DYNAMIC 340PS

380MM FRONT AND  
325MM REAR BRAKES



CALIPERS: BLACK (STANDARD) OR RED (OPTIONAL)  
STANDARD ON F-TYPE 380PS AND  
F-TYPE R-DYNAMIC 380PS

380MM FRONT AND  
376MM REAR BRAKES



CALIPERS: RED (STANDARD) OR BLACK (OPTIONAL)  
STANDARD ON F-TYPE R AND F-TYPE SVR  
OPTIONAL ON F-TYPE AND F-TYPE R-DYNAMIC

398MM FRONT AND  
380MM REAR CARBON  
CERAMIC BRAKES



CALIPERS: YELLOW (STANDARD)  
OPTIONAL ON MODELS WITH AUTOMATIC  
TRANSMISSION\*

\*Not available on 340PS engine.

For more details on brake availability refer to page 87 or configure your vehicle at [jaguar.com](http://jaguar.com)

# INCONTROL TECHNOLOGIES INFOTAINMENT AND CONNECTIVITY



TOUCH PRO

CONNECT PRO

InControl is our suite of cutting-edge technologies that link you to your F-TYPE, and both you and your F-TYPE to the wider world.

Every F-TYPE now features the Touch Pro infotainment system as standard. Incredibly responsive, with a highly intuitive user interface and sharp graphics, Touch Pro is the most advanced infotainment system that Jaguar has ever created. Its state-of-the-art technologies, including a quad-core processor and a high-speed 60GB solid-state drive, ensure Touch Pro makes every journey easier and more enjoyable.

This outstanding technology is further enhanced by its connectivity package: Connect Pro.



## TOUCH PRO

### STANDARD

- 8" Touchscreen with multi-touch gestures and customisable homescreens
- Instrument Cluster with 5" Central TFT Display
- Navigation Pro
- AM/FM Radio
- Bluetooth® and 2 x USB connections
- Meridian™ Sound System (380W)
- 10GB of usable memory



**Connect Pro** consists of InControl Apps, Remote Premium smartphone app, 4G Internet connection and Pro Services



**Protect** consists of SOS Emergency Call, Jaguar Optimised Assistance and Remote Essentials smartphone app



### OPTIONAL FEATURES

- Secure Tracker** provides Stolen Vehicle Monitoring and notifications via your smartphone and the secure call centre
- Meridian™ Surround Sound System (770W)
- Digital Audio Broadcasting (DAB)

As we roll out InControl, specific features described may be optional, and market or powertrain dependent. Please consult your country-specific Jaguar website or local Jaguar Retailer for availability and full terms in your country. Certain features require a Micro SIM with a suitable data contract which will require further subscription after the initial term advised by your Retailer. Mobile connectivity cannot be guaranteed in all locations.



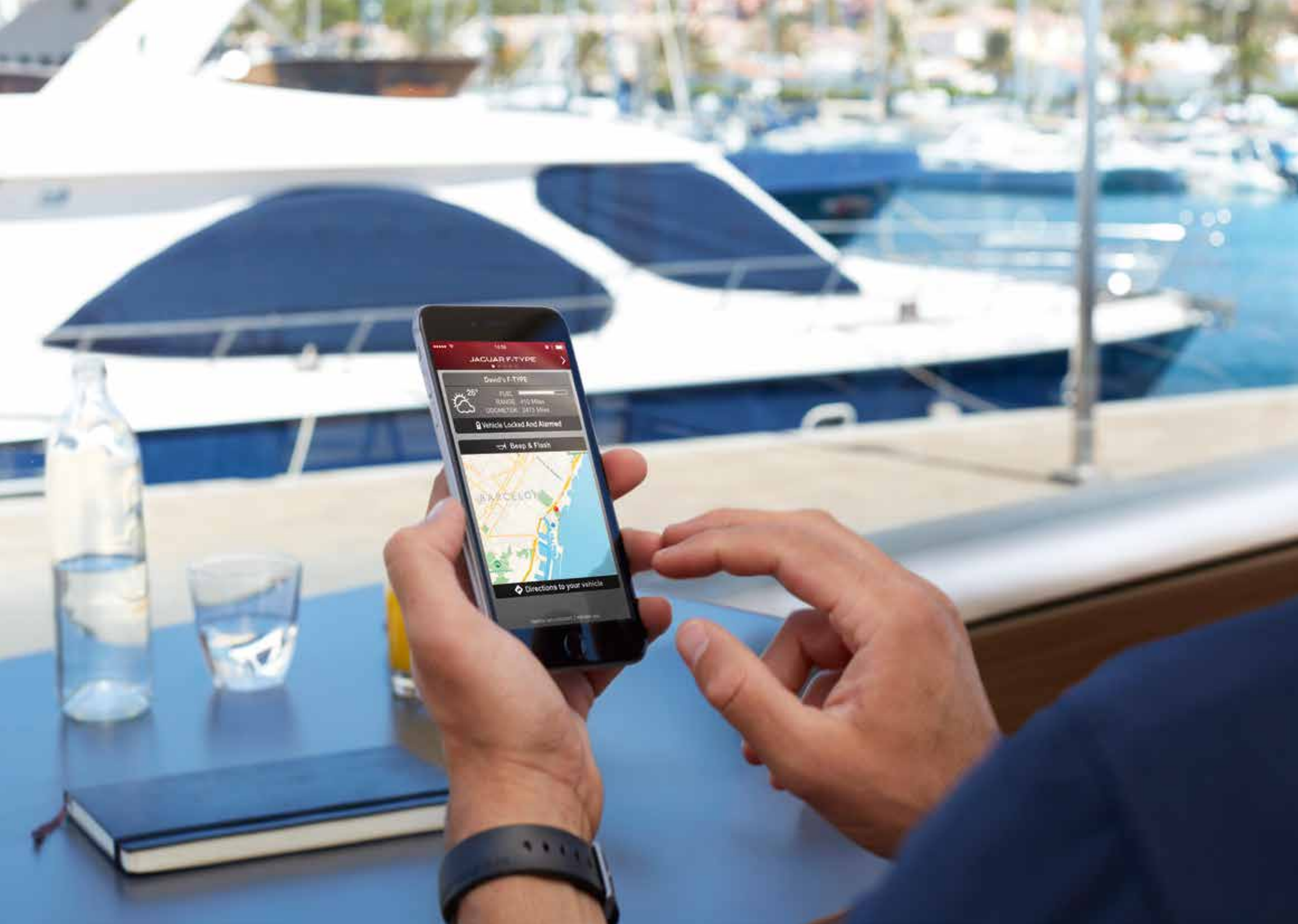

JAGUAR F-TYPE

David's F-TYPE

25°

FUEL

RANGE 410 Miles

DOOR LOCK 3473 Miles

Vehicle Locked And Alarmed

Beep & Flash

BARCELONA

Directions to your vehicle



SWIPE



PINCH



ZOOM

# TOUCH PRO



## NEXT GENERATION INFOTAINMENT

Touch Pro's next-generation hardware and software advances F-TYPE's connectivity and entertainment to the very highest level.

The key aspects of Touch Pro are:

**8" Touchscreen** at the heart of the centre console with customisable homescreen and lightning fast response times.

**Pinpoint touch control** allows you to manipulate and interact with information swiftly and seamlessly. The Touchscreen responds in the same manner as a smartphone or tablet computer, providing multi-touch gestures such as pinch, zoom and swipe.

**Navigation Pro** has response times that are a fraction of conventional systems. Set a destination and the system alerts you if you have insufficient fuel for the journey. It then displays filling stations on the part of the route where you may be low on fuel. The system automatically displays parking options.

**Personal media storage of 10GB** for your music and movies. 'Plug and play' using the two USB ports allowing for fast transfer speeds.

# CONNECT PRO



## ENHANCED CONNECTIVITY PACKAGE

Connect Pro's services, technologies and applications give you the very best in connectivity and convenience, all supported by a fast 4G Internet connection. It offers many features including:

**InControl Apps** features a range of Jaguar approved apps that can be connected to F-TYPE from your smartphone. It ensures safe and convenient use of apps optimised to enhance aspects of your in-car experience.

**Remote Premium** is an app that allows you to monitor as well as interact with your F-TYPE from your smartphone. Remote start F-TYPE to pre-condition the climate, lock and unlock the car, locate your F-TYPE on a map or using the beep and flash function, and track your journeys.

**Pro Services** is a comprehensive suite of connected services that includes:

**Real Time Traffic** uses millions of live traffic data feeds to give a highly accurate picture of traffic on the way to your destination, helping you choose the best route. As you progress, the system continues to monitor live traffic conditions, and can automatically reroute you to help avoid congestion.

**Route Planner Companion App** allows you to pre-plan your route via your Apple or Android smartphone. It guides you to your car, where you will find your selected route available on F-TYPE's Touchscreen. When you've completed your road journey, the app guides you to your final destination.

**Share your estimated time of arrival** so your selected contact(s) will know when you will arrive, as calculated by the navigation guidance system. The system can then send automatic updates via text or email, without any further action from you.

**Commute Mode** allows the system to learn your commutes and automatically advises you of the expected journey time and quickest routes based on live and historical traffic movements.



Explore InControl at [jaguar.com/incontrol](http://jaguar.com/incontrol)

As we roll out InControl, specific features described may be optional, and market or powertrain dependent. Please consult your country-specific Jaguar website or local Jaguar Retailer for availability and full terms in your country. Certain features require a Micro SIM with a suitable data contract which will require further subscription after the initial term advised by your Retailer. Mobile connectivity cannot be guaranteed in all locations.

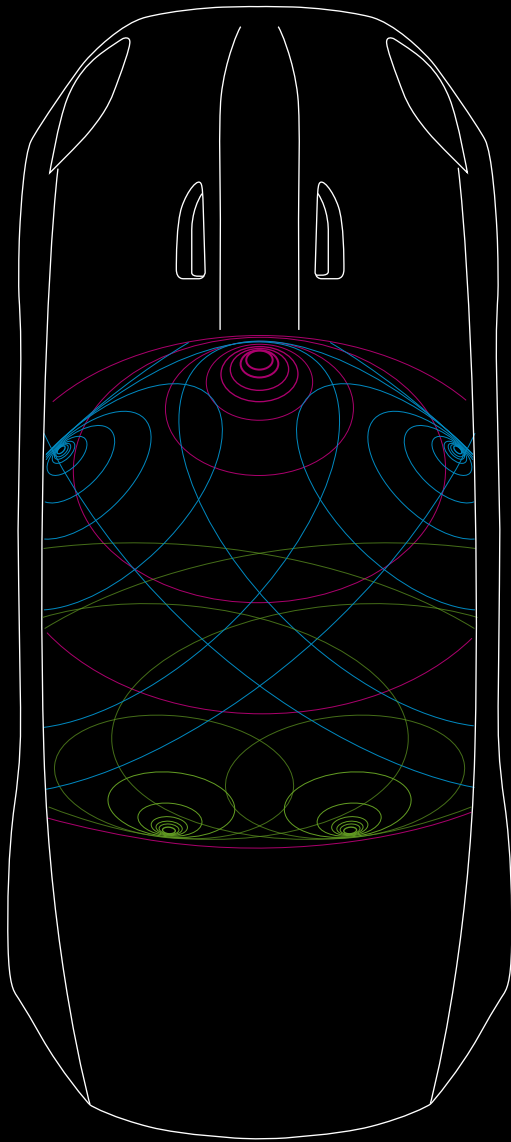

## AUDIO



MERIDIAN™ SOUND AND  
SURROUND SOUND SYSTEMS

ADVANCED  
TECHNOLOGY

Working with British audio experts Meridian™, we designed two high specification systems specifically for F-TYPE.

Digital Signal Processing (DSP) optimises Meridian's advanced Cabin Correction algorithm. This tailors the music to the unique acoustics of F-TYPE's interior. Dynamic Volume Control compensates for changes in sound levels, so you hear consistent sound through 10 speakers including 2 subwoofers, 380W and 10 channels.

The ultimate Meridian™ Surround Sound System for F-TYPE delivers 770W through 12 speakers. Using Meridian's exclusive Trifield™ technology, this advanced system delivers an authentic and consistent music experience.



-  Holographic Centre Image
-  Door Waves: Tweeter, Midrange and Bass
-  Surround Sound Waves

Diagram representative of Meridian™ Surround Sound System (770W).



MERIDIAN

**Standard**



**380**

WATTS

**10**



SPEAKERS INCLUDING  
2 SUBWOOFERS

**10**

AMPLIFIER CHANNELS

**MERIDIAN™ SOUND SYSTEM**

Dynamic Volume Control  
380 watts  
10 speakers including 2 subwoofers  
10 channel class D DSP amplifier

**Optional**



**770**

WATTS

**12**



SPEAKERS INCLUDING  
2 SUBWOOFERS

**13**

AMPLIFIER CHANNELS

**MERIDIAN™ SURROUND SOUND SYSTEM**

Dynamic Volume Control  
770 watts  
12 speakers including 2 subwoofers  
13 channel class D DSP amplifier  
Audyssey MultEQ Audio Equalisation  
7.1 Surround Sound  
Meridian Trifield™ Technology

'Trifield' and the 'three fields' device are trademarks of Trifield Productions Ltd.

VEHICLE SHOWN: F-TYPE R IN YULONG WHITE WITH OPTIONAL FEATURES FITTED (MARKET DEPENDENT)

# SAFETY

## ADVANCED DRIVER ASSISTANCE

F-TYPE's advanced technology is designed to keep you safe and take the stress out of driving. It can help with everything from reducing the chance of a motorway collision to avoiding minor bumps in a car park. This range of advanced active and passive safety systems give you the reassurance, information and control to focus on the pleasure of the drive.



### 1 BLIND SPOT MONITOR AND REVERSE TRAFFIC DETECTION

Blind Spot Monitor alerts you to vehicles or obstacles beside F-TYPE, as well as ones approaching from a distance behind, via an icon displayed in the appropriate exterior mirror. Reverse Traffic Detection alerts you via the Touchscreen of moving vehicles during reversing.



### 2 PARKING AIDS

The front and rear parking aids are designed to alert the driver with an audible warning to the presence of nearby objects. Arrows on the centre console Touchscreen provide further information on their location in relation to the vehicle.



### 3 PARK ASSIST

Our Park Assist system makes parallel parking in a tight spot easier than ever by steering your car into a suitable space. You just have to select the appropriate gear and control the car's speed. Park Assist will also steer you out of a space, taking all of the stress out of parking. Graphics and notifications guide you through both manoeuvres.



### 4 REVERSE PARK CAMERA

This option combines a rear-facing camera with Touchscreen information. It features coloured distance guides and on-screen guidance lines that move according to steering wheel angle to indicate the area into which the car will reverse.

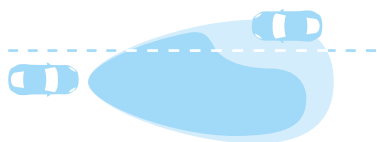

### 5 AUTO HIGH BEAM ASSIST

The Auto High Beam Assist system automatically switches between low and high beam when necessary, using a sensor mounted at the front of the rear view mirror.

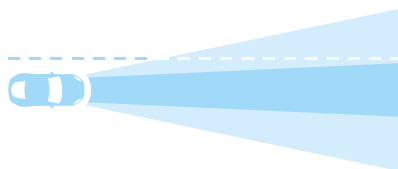

### 6 LED FRONT LIGHTING SYSTEM

This system automatically provides the best possible illumination in all driving situations by adjusting F-TYPE's headlight beam to your speed and the weather conditions. At slower speeds it widens the low beam to illuminate your peripheral vision, helping you to see pedestrians and junctions. At higher speeds the system raises and narrows the low beam for extended visibility.



### 7 PEDESTRIAN CONTACT SENSING SYSTEM

Help protect the people outside your car as well as those inside. If the car makes contact with a pedestrian, our industry-leading Pedestrian Contact Sensing System is designed to automatically raise the bonnet to help cushion a potential impact.



### 8 EMERGENCY BRAKE ASSIST

If the brakes are applied rapidly, this system boosts braking force to the maximum for shorter stopping distances. It can also help retain greater steering control in unexpected situations.

For more details on feature availability refer to pages 76-83 or configure your vehicle at [jaguar.com](http://jaguar.com)  
For information on airbags refer to page 76.

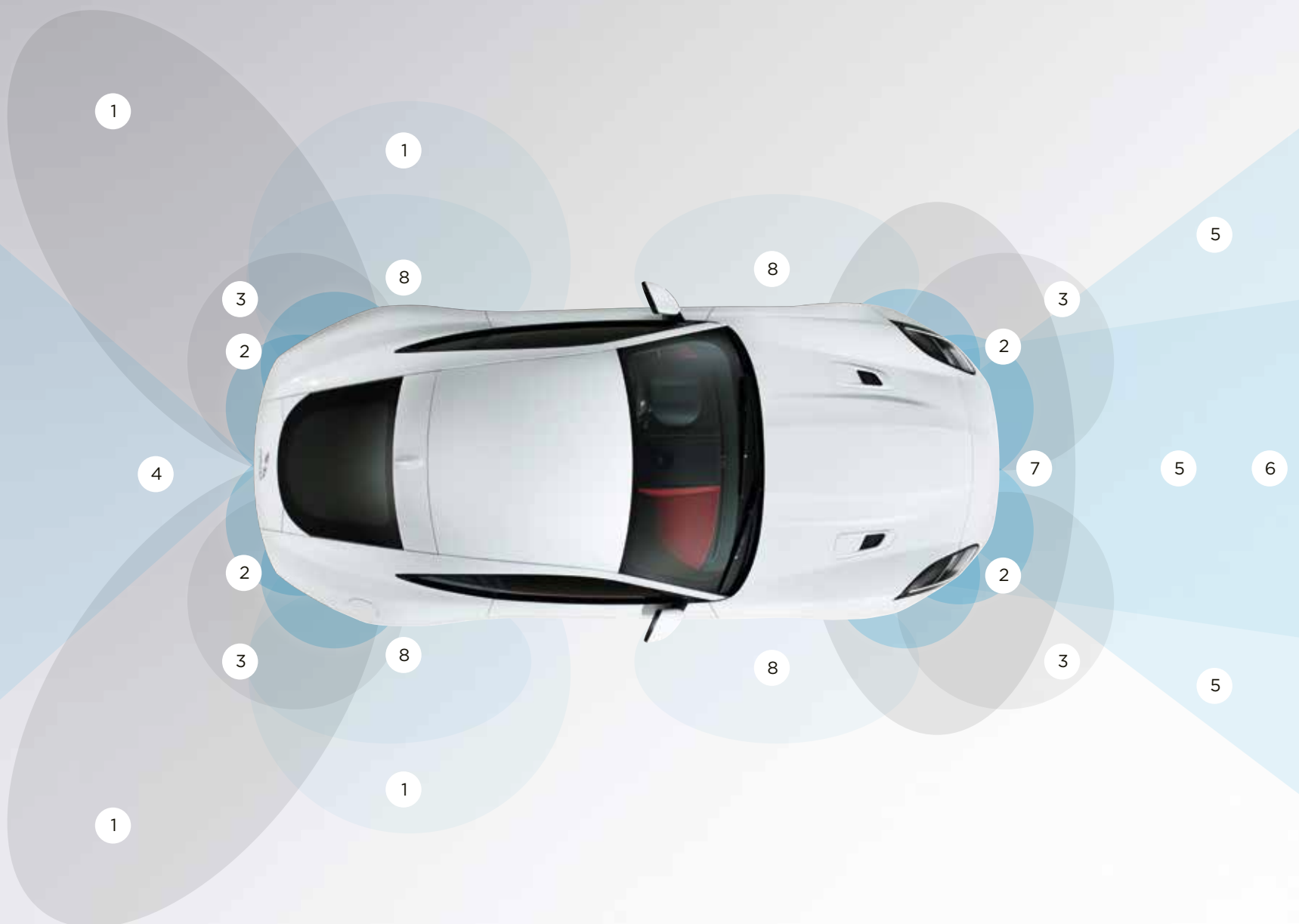

VEHICLE SHOWN: F-TYPE R IN YULONG WHITE WITH OPTIONAL EXTRAS (MARKET DEPENDENT)





# F-TYPE 400 SPORT SPECIAL EDITION

Only available for one model year, F-TYPE 400 SPORT is powered by an exclusive 400PS tune of the 3.0 litre V6 Supercharged engine. The added 20PS of power at the top of the rev range encourages you to push on into the high revs, towards the redline, where you can enjoy an even more dynamic drive. F-TYPE 400 SPORT has a potent combination of design features to match the increased engine power.

A muscular Sport Design Pack with sleek Dark Satin Grey trim strengthens on-road presence. Even the interior has added edge, with many design features carrying the bright 400 SPORT motif or Yellow contrast stitching. And to complement its distinctive style, F-TYPE 400 SPORT is available exclusively in Indus Silver, Santorini Black, or Yulong White metallic paint colours.

## UNIQUE F-TYPE 400 SPORT FEATURES

- 3.0 litre V6 400PS Supercharged Petrol engine available in Coupé or Convertible body style, RWD or AWD automatic transmission

### Exterior:

- Sport Design Pack with Dark Satin Grey and Gloss Black accents
- Dark Satin Grey exterior trim
- Black brake calipers with Yellow 400 SPORT script
- 20" Dark Satin Grey alloy wheels

### Interior:

- Premium leather interior with Yellow twin-needle stitching
- 400 SPORT Performance seats
- Interior Black Pack
- Aluminium gearshift paddles
- Interior 400 SPORT branding

To see the complete list of F-TYPE 400 SPORT standard features, and the extensive range of options and accessories available, visit [jaguar.com](http://jaguar.com)



**400**  
SPORT



# THE THEATRE OF DREAMS

# SPECIAL VEHICLE OPERATIONS

## JAGUAR'S CENTRE OF EXCELLENCE

Special Vehicle Operations (SVO) assembles and hand finishes halo models and limited run collector's editions, including the new F-TYPE SVR. Each one showcases the best of Jaguar with stunning performance, exceptional luxury and cutting-edge technology. With a dedicated team of designers, engineers and technicians, SVO takes precision engineering to new heights and offers the opportunity for more individuality, choice and personalisation. A car from SVO is the ultimate expression of Jaguar.

SVO is based at a brand new Technical Centre in Warwickshire, England. This 20,000m<sup>2</sup> specialist manufacturing facility has been established to enable our most discerning clients to indulge their passion for Jaguar. Our state-of-the-art facility features over 40 engineering inspection bays, a commissioning suite and an environmentally sustainable world-class paint facility.





# THE CONCEPT OF F-TYPE SVR



STATE-OF-THE-ART MATERIALS

ADVANCED AERODYNAMICS

F-TYPE SVR is designed and engineered at Special Vehicle Operations where our highly skilled engineers and aerodynamics experts have scrutinised every possible component to maximise F-TYPE SVR's performance. In both Coupé and Convertible form, it is the ultimate F-TYPE. State-of-the-art materials and advanced aerodynamic design push F-TYPE beyond the extraordinary with an exceptional powertrain that makes F-TYPE SVR our fastest production car ever. Delivering supreme performance, ride and handling, F-TYPE SVR creates once-in-a-lifetime driving experiences - every day.

F-TYPE SVR's lightweight All Wheel Drive system, with Intelligent Driveline Dynamics (IDD), delivers the engine's power with efficiency and control. The 5.0 litre V8 engine has been recalibrated to produce 575PS and 700Nm of torque, with a power-to-weight ratio of 337PS/tonne. It will take you from 0-100km/h in just 3.7 seconds and on to a top speed of 322km/h.\* But it is about more than numbers, more than just a machine. Jaguar makes performance an art. F-TYPE SVR is our latest masterpiece.

\*Coupé only.





## F-TYPE SVR AERODYNAMICS

**> MAXIMISED CAPABILITY** | **ADJUSTABLE DOWNFORCE**

F-TYPE SVR's performance is not expressed by its exterior design: it is created by it. Form follows function in every swooping curve and finely drawn line. Each unique styling element, down to the smallest, subtle detail, improves F-TYPE SVR. Its advanced aerodynamic design offers less drag and higher levels of downforce. As a result F-TYPE SVR slices cleanly through the air, achieving rapid acceleration and effortlessly efficient cruising. Strong downforce improves stability and handling, road holding and dynamic capability.

### FRONT INTAKES AND SPLITTER

Unique large lower bumper intakes maximise airflow for cooling of both the engine and brakes for improved performance. A precision splitter designed specially for F-TYPE SVR directs airflow into the car for optimum cooling. It also creates downforce at the front of the car to balance the rear wing.

### BONNET LOUVRES AND SIDE POWER VENTS

Uniquely shaped louvres maximise airflow through the engine bay. This aids cooling, so the engine can operate at the highest level. Air from the wheel housing is released through side power vents which manage airflow around the wheel arch to minimise drag and improve F-TYPE SVR's efficiency.

### ENHANCED COOLING

F-TYPE SVR's cooling system has been enhanced with significant improvements to airflow. To achieve this, the auxiliary radiator has been relocated, while the bumper beam profile and inlet trumpet size have been reduced. This increases the full performance envelope on F-TYPE SVR for greater endurance in extreme driving situations.

VEHICLE SHOWN ABOVE: F-TYPE SVR IN CALDERA RED WITH OPTIONAL FEATURES FITTED (MARKET DEPENDENT)  
VEHICLES SHOWN ON PREVIOUS PAGES: F-TYPE SVR IN CALDERA RED WITH OPTIONAL FEATURES FITTED (MARKET DEPENDENT)



### **AERODYNAMIC WING**

The aerodynamic wing is integral to F-TYPE SVR's enhanced performance. Compared with the standard F-TYPE Coupé's rear wing, F-TYPE SVR produces more downforce but crucially less drag. The wing is more elevated and wider than the standard F-TYPE Coupé's spoiler, enabling it to act over the whole width of the car rather than just the width of the boot lid.

Air passes both over and under the wing, allowing Bernoulli's principle to act in the car's favour - faster moving air underneath the wing is at a lower pressure than that passing over the top, resulting in additional downforce.

F-TYPE SVR's wing operates in two different positions:

On F-TYPE SVR Coupé the aerodynamic wing deploys at 113km/h and stows at 80km/h.

On F-TYPE SVR Convertible the aerodynamic wing deploys at 97km/h and stows at 64km/h.

### **DEPLOYED WING**

When F-TYPE SVR's wing is deployed it increases downforce for greater stability and improved handling at top speed. In this position the wing gives a drag coefficient reduction of 2.5 percent and a lift coefficient reduction of 15 percent.

### **STOWED WING**

For maximum top speed (V-Max), the wing is stowed to reduce drag. It works in conjunction with the front spoiler and other aerodynamic enhancements to bring a drag coefficient improvement of 7.5 percent and lift coefficient reduction of 45 percent.

### **V-MAX**

In order to achieve 322km/h\* you must consciously prepare your F-TYPE SVR. Select 'Dynamic Mode' and press the deployable aerodynamic wing switch for 3 seconds to enable V-Max Mode. While active, a permanent symbol appears on the instrument cluster. In this mode the spoiler remains stowed at all speeds keeping drag to a minimum.

### **REAR UNDERFLOOR AND DIFFUSER**

The smooth rear underfloor reduces drag, whilst the rear diffuser works with the rear underfloor to manage airflow, adding to F-TYPE SVR's stability.

\*Coupé only.





# F-TYPE SVR LIGHTWEIGHT TECHNOLOGIES



WEIGHT SAVING

INNOVATIVE DESIGN

Weight is the enemy of performance. So we designed F-TYPE SVR to be as lean as possible. Every gram has a reason to be there. Every milligram saved gives you more rapid acceleration, more agile handling and sharper braking. Yet the interior still offers comfort and luxury in equal measures. F-TYPE SVR has the capability to make performance effortlessly enjoyable.

## FORGED ALLOY WHEELS

F-TYPE SVR's bespoke Forged alloy wheels are fitted with unique Pirelli P ZERO™ tyres. Its tyres are 10mm wider than standard F-TYPE tyres, for improved handling and grip. While the striking Forged alloys offer a 13.8kg overall weight saving.

## CERAMIC BRAKES

F-TYPE SVR's optional CCM brakes save up to 21kg of weight compared with non-ceramic alternatives.

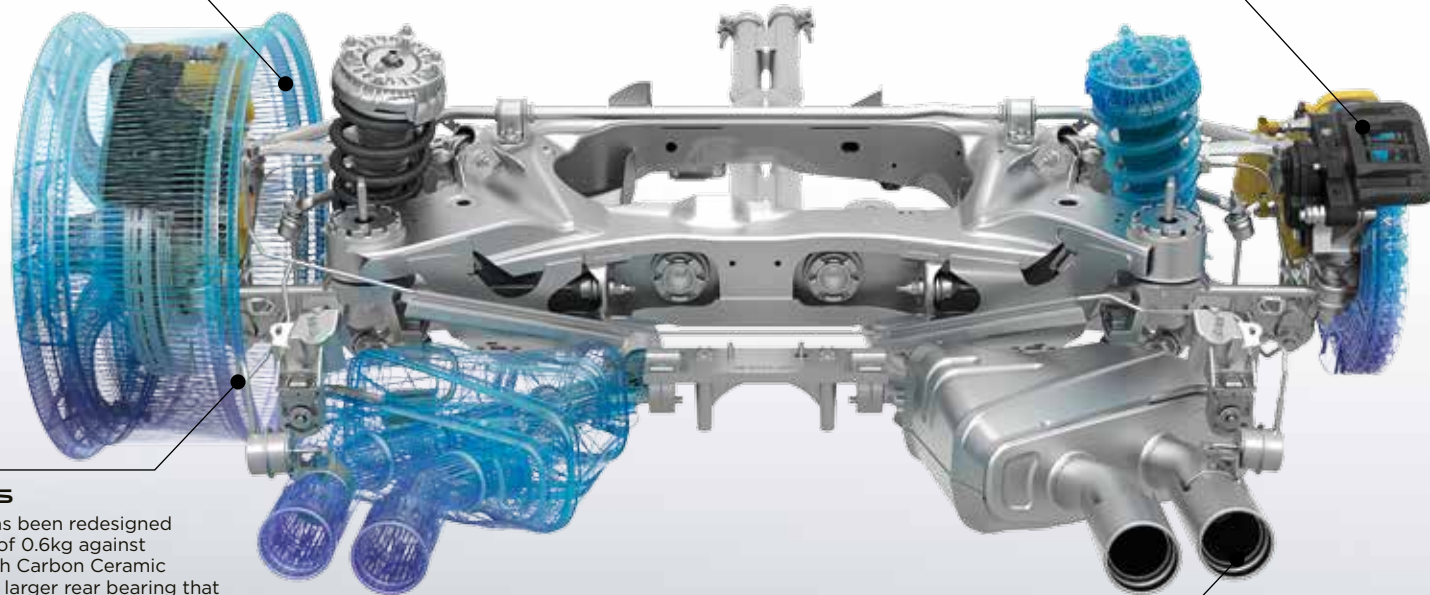

## REAR KNUCKLES

The suspension system has been redesigned enabling a weight saving of 0.6kg against conventional knuckles with Carbon Ceramic brakes. F-TYPE SVR has a larger rear bearing that contributes towards an increased stiffness of up to 37 percent over conventional F-TYPE knuckles. This enables the car to handle even higher lateral g-forces.

## TITANIUM EXHAUST

The lightweight Titanium and Inconel® exhaust system saves 16kg. With its SVR badged tailpipes, it not only looks unique, it sounds unique - F-TYPE SVR is recognisable by the distinctive rumble of its exhaust.



## F-TYPE SVR INTERIOR

 **UNIQUE DETAILS** | **SPORTING CRAFTSMANSHIP**

Just as no detail of F-TYPE SVR's engineering and exterior design has been overlooked, its interior is testament to the SVO division's attention to detail. The moment you open the door, the SVR treadplate shows that you are entering a special space.

Exclusive materials are everywhere you look, from fine contrast stitching to ultra-modern finishes that create a sense of total luxury. The SVR badged steering wheel with larger aluminium anodised gearshift paddles offers the perfect connection to the road and the quilted Performance seats offer comfort and support while you enjoy the dynamic drive.

VEHICLE SHOWN: F-TYPE SVR FEATURING EBONY QUILTED LEATHER PERFORMANCE SEATS WITH CIRRUS STITCH AND MICRO PIPING AND OPTIONAL FEATURES FITTED (MARKET DEPENDENT)



# PERSONALISATION F-TYPE - YOUR CHOICE

 Configure your vehicle at [jaguar.com](http://jaguar.com)



## CHOOSE YOUR ENGINE

### Page 70

Select one of F-TYPE's powerful, efficient petrol engines to suit your driving style.

## CHOOSE YOUR MODEL & OPTIONS

### Page 72

Compare the wealth of standard features and options on F-TYPE models.

## CHOOSE YOUR COLOUR

### Page 84

Express your individuality with one of F-TYPE's stunning exterior colours.



CHOOSE YOUR  
**WHEELS AND  
BRAKING SYSTEM**

**Page 86**

Complement your F-TYPE's stunning style with a set of beautifully designed alloy wheels.



CHOOSE YOUR  
**INTERIOR**

**Page 88**

There's a wide selection of premium materials, leathers and finishes for every personal taste.



CHOOSE YOUR  
**JAGUAR GEAR  
ACCESSORIES**

**Page 102**

Really make it yours by adding style, practicality and versatility with official F-TYPE Gear Accessories from your local Jaguar Retailer.

# 1 CHOOSE YOUR ENGINE

 Configure your vehicle at [jaguar.com](http://jaguar.com)

## > V6 ENGINES

### 3.0 LITRE V6

SUPERCHARGED PETROL [340PS] RWD  
MANUAL OR AUTOMATIC

MAXIMUM POWER 340PS

MAXIMUM TORQUE 450Nm

ACCELERATION 0-100 km/h  
Manual 5.7 seconds / Auto 5.3 seconds

TOP SPEED 260 km/h

COMBINED FUEL CONSUMPTION  
Manual 9.8 l/100km / Auto 8.4 l/100km

COMBINED CO<sub>2</sub>  
Manual 234 g/km / Auto 199 g/km

F-TYPE, F-TYPE R-DYNAMIC



MANUAL  
0-100 KM/H

MANUAL  
TOP SPEED KM/H



AUTO  
0-100 KM/H

AUTO  
TOP SPEED KM/H

### 3.0 LITRE V6

SUPERCHARGED PETROL [380PS] RWD  
MANUAL OR AUTOMATIC

MAXIMUM POWER 380PS

MAXIMUM TORQUE 460Nm

ACCELERATION 0-100 km/h  
Manual 5.5 seconds / Auto 4.9 seconds

TOP SPEED 275 km/h

COMBINED FUEL CONSUMPTION  
Manual 9.8 l/100km / Auto 8.6 l/100km

COMBINED CO<sub>2</sub>  
Manual 234 g/km / Auto 203 g/km

F-TYPE, F-TYPE R-DYNAMIC



MANUAL  
0-100 KM/H

MANUAL  
TOP SPEED KM/H



AUTO  
0-100 KM/H

AUTO  
TOP SPEED KM/H

### 3.0 LITRE V6

SUPERCHARGED PETROL [380PS] AWD  
AUTOMATIC

MAXIMUM POWER 380PS

MAXIMUM TORQUE 460Nm

ACCELERATION 0-100 km/h 5.1 seconds

TOP SPEED 275 km/h

COMBINED FUEL CONSUMPTION 8.9 l/100km

COMBINED CO<sub>2</sub> 211 g/km

F-TYPE, F-TYPE R-DYNAMIC



0-100 KM/H

TOP SPEED KM/H

\*Coupé only.

Official EU test figures. For comparison purposes only. Real world figures may differ.

## > V8 ENGINES

### 5.0 LITRE V8

SUPERCHARGED PETROL [550PS] AWD  
AUTOMATIC

MAXIMUM POWER 550PS

MAXIMUM TORQUE 680Nm

ACCELERATION 0-100 km/h 4.1 seconds

TOP SPEED 300 km/h

COMBINED FUEL CONSUMPTION 11.3 l/100km

COMBINED CO<sub>2</sub> 269 g/km

F-TYPE R

### 5.0 LITRE V8

SUPERCHARGED PETROL [575PS] AWD  
AUTOMATIC

MAXIMUM POWER 575PS

MAXIMUM TORQUE 700Nm

ACCELERATION 0-100 km/h 3.7 seconds

TOP SPEED 322 km/h\*

COMBINED FUEL CONSUMPTION 11.3 l/100km

COMBINED CO<sub>2</sub> 269 g/km

F-TYPE SVR



0-100 KM/H

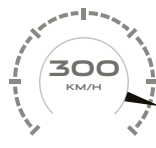

TOP SPEED KM/H



0-100 KM/H

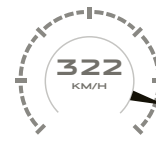

TOP SPEED KM/H

# 2 CHOOSE YOUR MODEL

 Configure your vehicle at [jaguar.com](http://jaguar.com)



## F-TYPE

### KEY FEATURES

Active Sports Exhaust  
Dynamic Mode  
Deployable boot lid spoiler  
Xenon Headlights with LED signature  
LED tail lights  
Infrared reflective windscreen  
Sport seats with leather and suedecloth facings  
6-way electric front seats  
Leather steering wheel with Silver gearshift paddles (automatic only)  
Knurled Aluminium centre console  
8" Touchscreen  
Meridian™ Sound System  
Navigation Pro System  
Bluetooth® connectivity

### 340PS

Passive suspension  
Open Differential with Torque Vectoring  
18" alloy wheels  
355mm front and 325mm rear brakes with Silver brake calipers

### 380PS

Adaptive Dynamics  
Limited Slip Differential with Torque Vectoring  
19" alloy wheels  
380mm front and 325mm rear brakes with Black brake calipers  
All Wheel Drive system (optional)



## F-TYPE R-DYNAMIC

### KEY FEATURES (IN ADDITION TO F-TYPE)

Switchable Active Sports Exhaust  
Design Pack in Gloss Black  
LED headlights with signature DRL  
Delta Aluminium centre console  
R-Dynamic treadplates

### 340PS

Passive suspension  
Open Differential with Torque Vectoring  
19" alloy wheels  
355mm front and 325mm rear brakes with Silver brake calipers

### 380PS

Adaptive Dynamics  
Limited Slip Differential with Torque Vectoring  
20" alloy wheels  
380mm front and 325mm rear brakes with Black brake calipers  
All Wheel Drive system (optional)

Vehicles shown are for illustrative purposes and may have optional features fitted. Options and availability should be verified with your local jaguar retailer.





## F-TYPE R

### KEY FEATURES

#### 550PS

- All Wheel Drive system
- 380mm front and 376mm rear brakes with Red brake calipers
- Electronic Active Differential with Torque Vectoring
- Configurable Dynamics Mode
- 20" R alloy wheels
- Bright metal pedals
- Premium leather interior
- R Performance seats
- 12-way electric front seats with memory
- R branded leather steering wheel with Silver gearshift paddles
- Linear Vee Aluminium centre console with R branding
- Configurable Ambient Interior Lighting
- Wind deflector (Convertible only)



## F-TYPE SVR

### KEY FEATURES (IN ADDITION TO F-TYPE R)

#### 575PS

- Lightweight Titanium and Inconel® exhaust
- 20" Forged alloy wheels
- Redesigned aerodynamics
- Carbon Fibre rear aerodynamic wing
- SVR Performance seats
- Suedecloth headlining
- Heated SVR branded leather steering wheel with aluminium gearshift paddles
- Dark Brushed Aluminium centre console with SVR branding
- Front Parking Aid

# 2 CHOOSE YOUR OPTIONS

 Configure your vehicle at [jaguar.com](http://jaguar.com)

## ROOF STYLES

F-TYPE offers a range of different roofs to suit your own personal style. Each delivering their own distinctive characteristics, they provide a powerful expression of individual flair both inside the cabin and to the outside world.



### ALUMINIUM ROOF

For the pure Coupé look, F-TYPE's aluminium roof is as strong and lightweight as the rest of the vehicle. It provides the ideal complement in colour, style and line to the powerful F-TYPE profile. The aluminium roof expresses F-TYPE in its clearest sports car form.



### PANORAMIC GLASS ROOF

Introducing even more natural light and airiness to the interior, a full width panoramic glass roof is optional on F-TYPE Coupé models. For increased seclusion, should it be required, the roof features a manually sliding 'black-out' blind, which can screen the occupants from up to 99 percent of the incoming light.



### CARBON FIBRE ROOF\*

With Carbon Fibre outer and inner panels bonded together to create a strong yet light roof structure, F-TYPE Coupé's optional Carbon Fibre roof is 20 percent lighter than the standard aluminium roof. It features Carbon Fibre weave visible through a deep, high-grade lacquered finish.



### CONVERTIBLE ROOF

F-TYPE Convertible's lightweight fabric roof is available in a choice of four colours. Acoustically enhanced with composite fabric to reduce noise, it features a flush fitting heated glass rear window. The roof can be raised or lowered in just 12 seconds and operated fully automatically at speeds of up to 50km/h.

\*Please consult your local Jaguar Retailer for availability.

VEHICLES SHOWN: F-TYPE R IN YULONG WHITE WITH OPTIONAL FEATURES FITTED (MARKET DEPENDENT)

CONVERTIBLE ROOF COLOURS

STANDARD

Black

OPTIONAL

Grey

Red

Beige

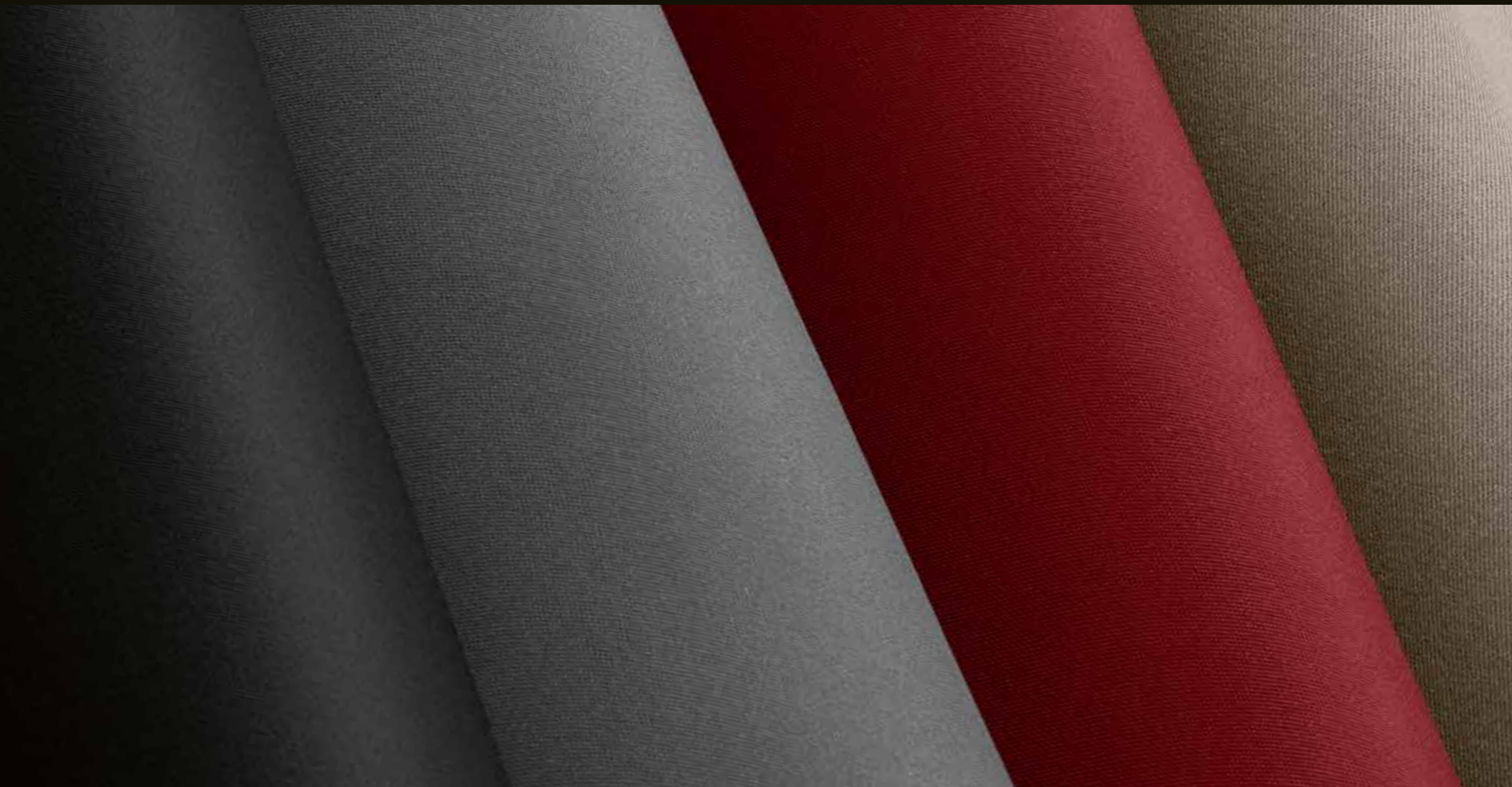

# 2 CHOOSE YOUR OPTIONS

 Configure your vehicle at [jaguar.com](http://jaguar.com)

## KEY STANDARD FEATURES

	F-TYPE	F-TYPE R-DYNAMIC	F-TYPE R	F-TYPE SVR	DESCRIPTION
Rain, Ice, Snow Mode	●	●	●	●	
Dynamic Stability Control (DSC)	●	●	●	●	
Airbags	●	●	●	●	4 airbags in Convertible, 6 airbags in Coupé
Electric Parking Brake (EPB)	●	●	●	●	
Emergency Brake Assist	●	●	●	●	
Anti-lock Braking System (ABS)	●	●	●	●	
Electronic Brake-force Distribution (EBD)	●	●	●	●	
Flush exterior door handles	●	●	●	●	
Body-coloured door mirror caps	●	●	●	●	
Rain sensing windscreen wipers	●	●	●	●	
LED tail lights	●	●	●	●	
Deployable front air vents	●	●	●	●	
Auto-dimming interior rear view mirror	●	●	●	●	
Overhead lighting console	●	●	●	●	
Twin front cupholders	●	●	●	●	
8" Touchscreen	●	●	●	●	
Power socket	●	●	●	●	
USB and 12V socket in centre console	●	●	●	●	
Remote central locking with deadlocks and drive-away locking	●	●	●	●	
Perimetric alarm and immobiliser	●	●	●	●	
Boot entrapment release lever	●	●	●	●	
Push Button Start	●	●	●	●	
Valet Mode	●	●	●	●	

● Standard ○ Option — Not available ■ Part of Pack

Please consult your local Jaguar Retailer for details.

For a complete list of optional features and packs refer to the F-TYPE Specification and Price Guide or configure your vehicle at [jaguar.com](http://jaguar.com)

## KEY OPTIONAL FEATURES

		F-TYPE (340PS)	F-TYPE (380PS)	F-TYPE R-DYNAMIC (340PS)	F-TYPE R-DYNAMIC (380PS)	F-TYPE R (550PS)	F-TYPE SVR (575PS)	
<b>TRANSMISSION AND DYNAMIC FEATURES</b>								<b>DESCRIPTION</b>
Carbon Fibre manual gearshift	C72J	○	○	○	○	—	—	Only available with manual transmission
Silver gearshift paddles	B66E	●	●	●	●	●	—	Only available with automatic transmission
Aluminium gearshift paddles	B66F	—	—	—	—	○	●	Only available with automatic transmission
Adaptive Dynamics	C35A	—	●	—	●	●	●	
Passive suspension	C35Z	●	—	●	—	—	—	
Dynamic Mode	B73J	●	●	●	●	—	—	
Configurable Dynamic Mode	B73K	—	○	—	○	●	●	
Open Differential with Torque Vectoring	C37E	●	—	●	—	—	—	
Limited Slip Differential with Torque Vectoring	C37F	—	●	—	●	—	—	
Electronic Active Differential with Torque Vectoring	C37D	—	—	—	—	—	●	
Active Sports Exhaust	S65B	●	●	—	—	—	—	
Switchable Active Exhaust	S65L	○	○	●	●	●	●	
<b>BRAKES</b>								
Silver brake calipers	C10W	●	—	●	—	—	—	
Red brake calipers	C10R	○	○	○	○	●	●	Only available as an option with 380mm front and 325mm rear brakes or 380mm front and 376mm rear brakes
Black brake calipers	C10Y	—	●	—	●	○	○	Only available as an option with 380mm front and 325mm rear brakes or 380mm front and 376mm rear brakes
Yellow brake calipers	C10P	—	■	—	■	■	■	Part of Carbon Ceramic Brake Pack
355mm front and 325mm rear brakes	G36F	●	—	●	—	—	—	
380mm front and 325mm rear brakes	G36N	—	●	—	●	—	—	Only available with Red brake calipers or Black brake calipers. Not available with 18" alloy wheels
380mm front and 376mm rear brakes	G36M	○	○	○	○	●	●	Only available with Red brake calipers or Black brake calipers. Not available with 18" wheels
398mm front and 380mm rear carbon ceramic brakes	G36P	—	■	—	■	■	■	Part of Carbon Ceramic Brake Pack

# 2 CHOOSE YOUR OPTIONS

 Configure your vehicle at [jaguar.com](http://jaguar.com)

EXTERIOR FEATURES AND FINISHERS		F-TYPE	F-TYPE R-DYNAMIC	F-TYPE R	F-TYPE SVR	
EXTERIOR FEATURES AND FINISHERS		CODE				DESCRIPTION
Black fully electric convertible roof	LPDE	●	●	●	●	Only available on Convertible
Grey fully electric convertible roof	LLKB	○	○	○	○	Only available on Convertible
Red fully electric convertible roof	LCHH	○	○	○	○	Only available on Convertible
Beige fully electric convertible roof	LSAL	○	○	○	○	Only available on Convertible
Gloss Black roll over protection bars	B67B	■	■	■	●	Only available on Convertible. Part of Black Exterior Pack
Satin Chrome roll over protection bars	B67C	●	●	●	—	Only available on Convertible
Carbon Fibre roof	F45B	○	○	○	○	Only available on Coupé
Panoramic glass roof	F45A	○	○	○	○	Only available on Coupé
Powered boot lid	B69B	○	○	○	○	Only available on Coupé
Deployable rear spoiler	B09M	●	●	●	○	Reduces top speed of F-TYPE SVR to 300km/h when selected
Fixed rear spoiler	B09F	○	○	○	—	Only available on Coupé. Requires Switchable Active Exhaust
Carbon Fibre rear aerodynamic wing	B09C	—	—	—	●	
GLASS AND EXTERIOR MIRRORS						
Heated windscreen	D96A	○	○	○	○	
Heated door mirrors	B28J	●	●	—	—	
Power fold, heated door mirrors	B28R	○	○	—	—	
Power fold, heated door mirrors with memory	B28V	■	■	●	●	Part of Seat Memory Pack 1
Auto-dimming, power fold, heated door mirrors	B28W	○	○	—	—	
Auto-dimming, power fold, heated door mirrors with memory	B28T	■	■	○	○	Part of Seat Memory Pack 2
Infrared reflective windscreen	D97B	●	●	●	●	
HEADLIGHTS AND LIGHTING						
Xenon headlights with LED signature	D90L	●	—	—	—	
LED headlights with signature DRL	D90R	○	●	●	●	
Auto High Beam Assist (AHBA)	D91A	○	○	○	○	Only available with LED headlights with signature DRL
EXTERIOR COLOURS						
Solid paint		●	●	●	●	
Metallic paint		○	○	○	○	
Premium metallic paint		○	○	○	—	
WHEELS						
Reduced section alloy spare wheel	C40D	○	○	○	○	Not available with Carbon Ceramic Brake Pack
Tyre Repair System	C40S	●	●	●	●	

## INTERIOR SEATING

SEATING	CODE	F-TYPE	F-TYPE R-DYNAMIC	F-TYPE R	F-TYPE SVR	DESCRIPTION
Sport seats	B55A	●	●	—	—	
Performance seats	B55C	○	○	■	—	Linked to Premium Leather Interior Pack, Suedecloth Interior Pack or Full Premium Leather Interior Pack on F-TYPE and F-TYPE R-Dynamic. R embossing is removed on F-TYPE R with Suedecloth Interior Pack and Full Premium Leather Interior Pack
R Performance seats	B55D	—	—	●	—	
SVR Performance seats	B55H	—	—	—	●	
Grained leather and suedecloth seats	B40N	●	●	—	—	
Windsor leather seats	B41H	■	■	●	—	Part of Premium Leather Interior Pack
Suedecloth and Windsor leather seats with contrast stitching	B41J	■	■	■	—	Part of Suedecloth Interior Pack
Lozenge quilted leather	B41U	—	—	—	●	
Red seat belts	RCHX	○	○	○	○	Red seat belts can be fitted to Ebony seats with Ebony stitching, Pimento contrast stitching or Pimento seats
6-way electric front seats	H53B	●	●	—	—	
12-way electric front seats with memory	H53D	■	■	●	●	Part of Seat Memory Packs
Heated front seats	F53A	○	○	○	—	Only available with Sport seats or suedecloth Performance seats
Heated and cooled front seats	F53F	○	○	○	○	Only available with Performance seats. Not available on suedecloth seats

## HEADLINING

HEADLINING		F-TYPE	F-TYPE R-DYNAMIC	F-TYPE R	F-TYPE SVR	DESCRIPTION
						Refer to Page 88-89 for full details on interior colour availability
Leather headlining	H01C	■	■	■	■	Requires Extended Leather Pack
Suedecloth headlining	H01D	■	■	■	●	Requires Suedecloth Upper Environment Pack
Morzine headlining	H01E	●	●	●	—	
Ebony headlining	HPDB	●	●	●	●	
Grey headlining	HLFZ	○	○	○	—	
Pimento headlining	HCHX	○	○	○	○	Not available on Coupé. Leather Only
Ivory headlining	HNAA	○	○	○	—	Not available with panoramic glass roof. Leather Only

● Standard ○ Option — Not available ■ Part of Pack

Please consult your local Jaguar Retailer for details.

For a complete list of optional features and packs refer to the F-TYPE Specification and Price Guide or configure your vehicle at [jaguar.com](http://jaguar.com)

Refer to page 88-89 for full details on interior colour availability.

# 2 CHOOSE YOUR OPTIONS

 Configure your vehicle at [jaguar.com](http://jaguar.com)

## INTERIOR FEATURES

INTERIOR FEATURES	CODE	F-TYPE	F-TYPE R-DYNAMIC	F-TYPE R	F-TYPE SVR	DESCRIPTION
Sunvisors	F57B	●	●	—	—	
Sunvisors with vanity mirrors	F57C	○	○	●	—	Only available in Ebony or Grey
Suedecloth sunvisors with vanity mirrors	F57G	■	■	■	●	Part of Suedecloth Upper Environment Pack
Leather sunvisors with vanity mirrors	F57A	■	■	■	■	Part of Extended Leather Pack
Bright metal pedals	G48S	○	○	●	●	Only available with automatic transmissions
Wind deflector	B74A	○	○	●	●	Only available on Convertible
Electrically adjustable steering column	D07E	●	●	—	—	
Electrically adjustable steering column with memory	D07F	■	■	●	●	Part of Memory Packs. Not available with grained leather and suedecloth Sport seats
Leather steering wheel	F95Y	●	●	—	—	
Flat-bottom leather steering wheel	F96V	○	○	—	—	
Flat-bottom leather steering wheel with Black spokes	F96S	■	■	—	—	Part of Interior Black Pack
R branded leather steering wheel	F96L	—	—	●	—	
R branded flat-bottom leather steering wheel	F95R	—	—	○	—	
R branded flat-bottom leather steering wheel with Black spokes	F96U	—	—	■	—	Part of Interior Black Pack
SVR branded leather steering wheel	F96Q	—	—	—	●	
SVR branded suedecloth steering wheel	F96P	—	—	—	○	Not available with heated steering wheel
Heated steering wheel	F97A	○	○	○	●	
Premium carpet mats	H69R	●	●	—	—	
Sport carpet mats	H69L	○	○	—	—	
Nubuck edged carpet mats	H69N	—	—	—	●	
Contrast carpet mats	H69V	■	■	●	—	Part of Full Premium Leather Interior Pack

● Standard ○ Option — Not available ■ Part of Pack

Please consult your local Jaguar Retailer for details.

For a complete list of optional features and packs refer to the F-TYPE Specification and Price Guide or configure your vehicle at [jaguar.com](http://jaguar.com)



INTERIOR FEATURES [CONTINUED]	CODE	F-TYPE	F-TYPE R-DYNAMIC	F-TYPE R	F-TYPE SVR	DESCRIPTION
Single-zone Climate Control	C88J	●	●	●	●	
Two-zone Climate Control	C88H	○	○	○	○	
Air Quality Sensor	C89A	○	○	○	○	
Configurable Ambient Interior Lighting	B65D	○	○	●	●	
Illuminated metal treadplates with Jaguar script	F28F	○	○	○	○	

## SAFETY AND SECURITY

SAFETY AND SECURITY	CODE	F-TYPE	F-TYPE R-DYNAMIC	F-TYPE R	F-TYPE SVR	DESCRIPTION
Pedestrian Contact Sensing	B93A	●	●	●	●	
Garage door opener (HomeLink®)	B39N	○	○	○	○	Only available on Convertible. Not available with headlights with Auto High Beam Assist
Keyless Entry	F04B	○	○	●	●	
Tyre Pressure Monitoring System (TPMS)	C42R	●	●	●	●	
Blind Spot Monitor and Reverse Traffic Detection	H71C	○	○	○	○	Requires auto-dimming exterior mirrors
Rear View Camera	C14A	○	○	○	○	
Cruise Control and Speed Limiter	H41C	●	●	●	●	
Front Parking Aid	C13A	○	○	○	●	
Rear Parking Aid	C11A	●	●	●	●	
Park Assist	C18A	○	○	○	○	Requires Front Parking Aid and Rear View Camera

# 2 CHOOSE YOUR OPTIONS

 Configure your vehicle at [jaguar.com](http://jaguar.com)

## INFORMATION, COMMUNICATION AND ENTERTAINMENT

		F-TYPE	F-TYPE R-DYNAMIC	F-TYPE R	F-TYPE SVR
<b>INFORMATION AND COMMUNICATION</b>					
Protect	D45D	●	●	●	●
Remote Premium for warranty period	D47A	●	●	●	●
InControl Apps	H57A	●	●	●	●
Touch Pro System	G64D	●	●	●	●
Navigation Pro System	G50H	●	●	●	●
Secure Tracker for warranty period	D44A	○	○	○	○
Pro Services	A44J	●	●	●	●
Bluetooth® connectivity	H74V	●	●	●	●
5" central TFT display with instrument panel - 300km/h	P50R	●	●	—	—
5" central TFT display with instrument panel - 320km/h	P50Q	—	—	●	●
<b>AUDIO</b>					
Digital Audio Broadcast (DAB) Radio	B51A	○	○	○	○
Meridian™ Sound System (380W)	B44V	●	●	●	●
Meridian™ Surround Sound System (770W)	B43U	○	○	○	○

● Standard ○ Option — Not available ■ Part of Pack

Please consult your local Jaguar Retailer for details.

For a complete list of optional features and packs refer to the F-TYPE Specification and Price Guide or configure your vehicle at [jaguar.com](http://jaguar.com)

## OPTION PACKS

		F-TYPE	F-TYPE R-DYNAMIC	F-TYPE R	F-TYPE SVR	DESCRIPTION
Black Exterior Pack	Z93L	○	○	○	—	Gloss Black finish to side window surrounds (Coupé only), front bumper splitter, front grille surround, side power vents, bonnet louvres, rear valance and roll over protection bars (Convertible only).*
Exterior Design Pack	Z93M	—	○	○	—	Body coloured front bumper splitter, side sills and rear venturi*
Exterior Black Design Pack	Z93N	—	○	○	—	Body coloured front bumper splitter, side sills and rear venturi. Gloss Black finish to side window surrounds (Coupé only), front grille surround, side power vents, bonnet louvres and roll over protection bars (Convertible only)*
Exterior Carbon Fibre Pack	Z94K	—	○	○	—	Body coloured front bumper splitter, side sills and rear venturi. Gloss Black finish to side window surrounds (Coupé only) and front grille surround. Carbon Fibre side power vents, bonnet louvres, mirror caps and roll over protection bars (Convertible only)*
Exterior Carbon Fibre Pack SVR	Z94I	—	—	—	○	Carbon Fibre side power vents, bonnet louvres, mirror caps, front bumper splitter, rear venturi and roll over bars (Convertible only)
Carbon Ceramic Brake Pack with 20" alloy wheels	Z73N	○	○	○	—	Yellow brake calipers, Tyre Repair System, 20" 5 split-spoke 'Style 5040' alloy wheels with metallic Black finish, 398mm front and 380mm rear carbon ceramic brakes, Bright metal pedals. Requires 380PS automatic or F-TYPE R
Carbon Ceramic Brake Pack with SVR Forged alloy wheels	Z73R	—	—	—	○	Yellow brake calipers, Tyre Repair System, 20" 10 spoke 'Style 1041' forged alloy wheels with Satin Black Diamond Turned finish, 398mm front and 380mm rear carbon ceramic brakes, Bright metal pedals
Seat Memory Pack 1	Z15V	○	○	—	—	Power fold, heated door mirrors with memory, electrically adjustable steering column with memory, 12-way electric front seats with memory
Seat Memory Pack 2	Z15W	○	○	—	—	Auto-dimming, power fold, heated door mirrors with memory, electrically adjustable steering column with memory, 12-way electric front seats with memory
Extended Leather Pack	Z23C	○	○	○	○	Leather sunvisors with vanity mirrors, leather headlining**
Suedecloth Upper Environment Pack	Z23D	○	○	○	—	Suedecloth sunvisors with vanity mirrors, suedecloth headlining
Climate Pack 1	Z88K	○	○	○	—	2-zone climate control, heated windscreen, heated front seats, heated steering wheel
Climate Pack 2	Z88L	○	○	○	○	2-zone climate control, heated windscreen, heated and cooled front seats, heated steering wheel
Premium Leather Interior Pack	Z84M	○	○	—	—	Premium leather door trim, Windsor leather seats, Windsor leather console, Windsor leather wrapped instrument panel topper
Full Premium Leather Interior Pack	Z84T	○	○	○	○	Premium leather door trim with twin stitching, premium leather interior with twin stitching - console, premium leather wrapped instrument panel topper with twin stitching, contrast carpet mats†
Suedecloth Interior Pack	TP22	○	○	○	—	Suedecloth door trim, suedecloth and Windsor leather seats with contrast stitching, Performance seats, suedecloth sunvisors with vanity mirrors, suedecloth headlining, premium leather console with twin stitching, suedecloth wrapped instrument panel topper with contrast stitching
Interior Black Pack	Z01P	○	○	○	—	Black vent surrounds, Gloss Black instrument cluster dial rings, Gloss Black door release and flat-bottom leather steering wheel with Black spokes. (R branded on F-TYPE R)

\*Pack content varies between models. \*\*Vehicle must have Premium Leather Interior Pack or Full Premium Leather Interior Pack.

†Performance seats only. Only available in Pimento Red and Siena Tan full premium leather interiors. R embossing is removed on F-TYPE R.

Refer to Page 88-89 for full details on interior colour availability when selecting an Interior Pack.

# 3 CHOOSE YOUR COLOUR

 [Configure your vehicle at jaguar.com](https://www.jaguar.com)

## SOLID

Narvik Black

Fuji White

Caldera Red

## METALLIC

Santorini Black

Yulong White

Corris Grey

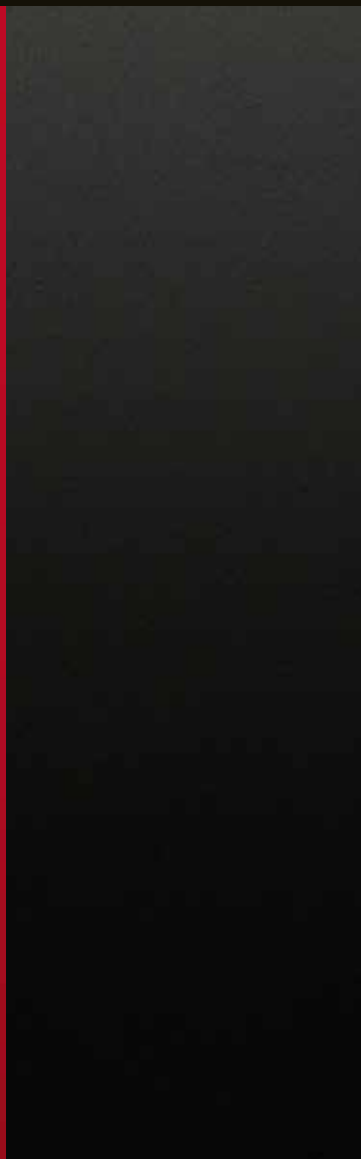
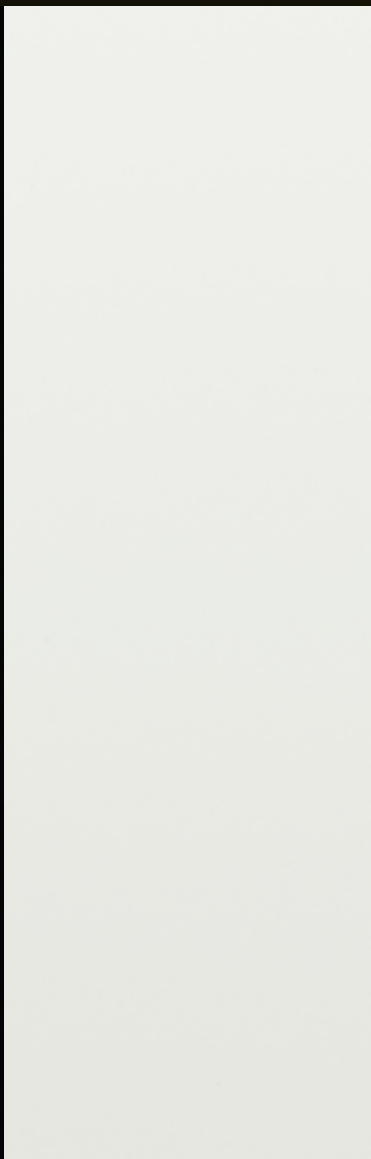

PREMIUM

Indus Silver



British Racing Green



Loire Blue



Ultra Blue



Carpathian Grey



Silicon Silver



# 4 CHOOSE YOUR WHEELS AND BRAKING SYSTEMS

 Configure your vehicle at [jaguar.com](http://jaguar.com)



18" 10 SPOKE  
'STYLE 1024'



19" 10 SPOKE  
'STYLE 1023'



19" 7 SPLIT-SPOKE  
'STYLE 7013'



19" 5 SPLIT-SPOKE  
'STYLE 5058'



20" 6 SPLIT-SPOKE  
'STYLE 6003'

ALLOY WHEEL FINISH	Silver	Silver	Silver	Technical Grey and Diamond Turned	Dark Grey and Diamond Turned
FRONT ALLOY WHEELS	8.5J x 18"	8.5J x 19"	8.5J x 19"	8.5J x 19"	9.0J x 20"
FRONT TYRES	245/45 R18	245/40 R19	245/40 R19	245/40 R19	255/35 R20
REAR ALLOY WHEELS	9.5J x 18"	9.5J x 19"	9.5J x 19"	9.5J x 19"	10.5J x 20"
REAR TYRES	275/40 R18	275/35 R19	275/35 R19	275/35 R19	295/30 R20
CODE	C51C	C51B	C51E	C50T	C52B
F-TYPE 340PS	●	○	○	○	○
F-TYPE 380PS	—	●	○	○	○
F-TYPE R-Dynamic 340PS	—	—	●	○	○
F-TYPE R-Dynamic 380PS	—	—	—	—	●
F-TYPE R	—	—	—	—	○
F-TYPE SVR	—	—	—	—	—



20" 5 SPOKE  
'STYLE 5060'



20" 5 SPLIT-SPOKE  
'STYLE 5061'



20" 5 SPOKE  
'STYLE 5042'



20" 5 SPLIT-SPOKE  
'STYLE 5040'



FORGED 20" 10 SPOKE  
'STYLE 1041'

ALLOY WHEEL FINISH	Silver	Satin Grey	Carbon Fibre, Satin Grey and Diamond Turned	Metallic Black	Satin Black and Diamond Turned
FRONT ALLOY WHEELS	9.0J x 20"	9.0J x 20"	9.0J x 20"	9.0J x 20"	9.0J x 20"
FRONT TYRES	255/35 R20	265/35 R20	255/35 R20	255/35 R20	265/35 R20
REAR ALLOY WHEELS	10.5J x 20"	11.0J x 20"	10.5J x 20"	10.5J x 20"	11.0J x 20"
REAR TYRES	295/30 R20	305/30 R20	295/30 R20	295/30 R20	305/30 R20
CODE	C55B	C55U	C51M	C53I	C55S
F-TYPE 340PS	○	—	○	—	—
F-TYPE 380PS	○	—	○	■*	—
F-TYPE R-Dynamic 340PS	○	—	○	—	—
F-TYPE R-Dynamic 380PS	○	—	○	■*	—
F-TYPE R	●	—	○	■*	—
F-TYPE SVR	—	●	—	—	■

355MM FRONT AND  
325MM REAR BRAKES



380MM FRONT AND  
325MM REAR BRAKES



380MM FRONT AND  
376MM REAR BRAKES



398MM FRONT AND  
380MM REAR CARBON  
CERAMIC BRAKES



BRAKING SYSTEMS	CODE	F-TYPE (340PS)	F-TYPE (380PS)	F-TYPE R-DYNAMIC (340PS)	F-TYPE R-DYNAMIC (380PS)	F-TYPE R (550PS)	F-TYPE SVR (575PS)	DESCRIPTION
355mm front and 325mm rear brakes	G36F	●	—	●	—	—	—	
380mm front and 325mm rear brakes	G36N	—	●	—	●	—	—	Only available with Red brake calipers or Black brake calipers. Not available with 18" wheels
380mm front and 376mm rear brakes	G36M	○	○	○	○	●	●	Only available with Red brake calipers or Black brake calipers. Not available with 18" wheels
398mm front and 380mm rear carbon ceramic brakes	G36P	—	■*	—	■*	■	■	Part of Carbon Ceramic Brake Pack with 20" alloy wheels and Carbon Ceramic Brake Pack with SVR forged alloy wheels

● Standard ○ Option — Not Applicable ■ Part of Pack

\*Automatic transmission only.

Please consult your local Jaguar Retailer for details.

For a complete list of optional features and Packs refer to the F-TYPE Specification and Price Guide or configure your vehicle at [jaguar.com](http://jaguar.com)

# 5 CHOOSE YOUR INTERIOR

 Configure your vehicle at [jaguar.com](http://jaguar.com)

F-TYPE AND F-TYPE R-DYNAMIC						
	SEAT WITH STITCH	UPPER FACIA WITH STITCH	INTERIOR TRIM AND OPTION CODES	HEADLINING	CARPETS	SEAT BELTS
<b>Standard</b>						
Sport seats with leather and suedecloth facings	Ebony with Ebony	Ebony with Ebony	TP01	Ebony or Grey	Ebony	Ebony or Red
	Cirrus with Cirrus	Ebony with Ebony	TP04	Ebony or Grey	Ebony	Ebony
<b>Optional</b>						
Sport seats in premium leather and premium leather interior <sup>1</sup>	Ebony with Ebony	Ebony with Ebony	TP01+Z84M	Ebony, Grey or Ivory <sup>3</sup>	Ebony	Ebony or Red
	Cirrus with Cirrus	Ebony with Ebony	TP04+Z84M	Ebony or Grey	Ebony	Ebony
Performance seats in premium leather and premium leather interior <sup>1</sup>	Ebony with Ebony	Ebony with Ebony	TP01+B55C+Z84M	Ebony, Grey or Ivory <sup>3</sup>	Ebony	Ebony or Red
	Ebony with Pimento	Ebony with Ebony	TP05	Ebony, Grey or Pimento <sup>4</sup>	Ebony	Ebony or Red
	Ebony with Siena Tan	Ebony with Ebony	TP33	Ebony or Grey	Ebony	Ebony
	Ebony with Ivory	Ebony with Ebony	TP29	Ebony, Grey or Ivory <sup>3</sup>	Ebony	Ebony
	Siena Tan with Cirrus	Ebony with Ebony	TP38	Ebony or Grey	Ebony	Ebony
	Brogue with Ivory	Ebony with Ebony	TP11	Ebony, Grey or Ivory <sup>3</sup>	Ebony	Ebony
	Pimento with Ebony	Ebony with Ebony	TP12	Ebony, Grey or Pimento <sup>4</sup>	Ebony	Ebony or Red
	Ivory with Ebony	Ebony with Ebony	TP28	Ebony, Grey or Ivory <sup>3</sup>	Ebony	Ebony
Performance seats in premium leather and suedecloth and premium leather interior <sup>1</sup>	Ebony with Cirrus	Ebony with Cirrus	TP22	Ebony suedecloth	Ebony	Ebony
Performance seats in premium leather and extended leather upper fascia <sup>2</sup>	Pimento with Ebony	Pimento with Ebony	TP23	Ebony or Pimento <sup>4</sup>	Ebony	Ebony or Red
	Siena Tan with Cirrus	Siena Tan with Cirrus	TP34	Ebony	Ebony	Ebony

<sup>1</sup>Premium leather interior adds premium leather to the upper fascia, centre console and door casings.

<sup>2</sup>Includes coloured premium leather passenger side upper fascia, upper door casings, centre console and Ebony carpet mats with coloured Nubuck edging and Ebony contrast stitching.

<sup>3</sup>Ivory leather headlining not available with panoramic glass roof.

<sup>4</sup>Pimento leather headlining available on Convertible only.

Please consult your local Jaguar Retailer for details.



F-TYPE R						
	SEAT WITH STITCH	UPPER FACIA WITH STITCH	INTERIOR TRIM AND OPTION CODES	HEADLINING	CARPETS	SEAT BELTS
<b>Standard</b>						
Performance seats in premium leather with R embossed headrests and premium leather interior	Ebony with Ebony	Ebony with Ebony	TP01	Ebony, Grey or Ivory <sup>3</sup>	Ebony	Ebony or Red
	Ebony with Ivory	Ebony with Ivory	TP17	Ebony, Grey or Ivory <sup>3</sup>	Ebony	Ebony
	Ebony with Pimento	Ebony with Pimento	TP24	Ebony, Grey or Pimento <sup>4</sup>	Ebony	Ebony or Red
	Ebony with Siena Tan	Ebony with Siena Tan	TP36	Ebony or Grey	Ebony	Ebony
	Siena Tan and Ebony duo tone with Siena Tan	Ebony with Siena Tan	TP37	Ebony or Grey	Ebony	Ebony
	Ivory and Ebony duo tone with Ivory	Ebony with Ivory	TP20	Ebony, Grey or Ivory <sup>3</sup>	Ebony	Ebony
	Pimento and Ebony duo tone with Pimento	Ebony with Pimento	TP19	Ebony, Grey or Pimento <sup>4</sup>	Ebony	Ebony or Red
<b>Optional</b>						
Performance seats in premium leather and suedecloth and premium leather interior	Ebony with Cirrus	Ebony with Cirrus	TP22	Ebony Suedecloth	Ebony	Ebony
Performance seats in premium leather and extended leather upper fascia <sup>2</sup>	Pimento with Ebony	Pimento with Ebony	TP23	Ebony or Pimento <sup>4</sup>	Ebony	Ebony or Red
	Siena Tan with Cirrus	Siena Tan with Cirrus	TP34	Ebony	Ebony	Ebony
F-TYPE SVR						
	SEAT WITH STITCH	UPPER FACIA WITH STITCH	INTERIOR TRIM AND OPTION CODES	HEADLINING	CARPETS	SEAT BELTS
<b>Standard</b>						
Quilted Performance seats in premium leather with SVR embossed headrests and suedecloth driver's instrument panel area	Ebony with Cirrus	Ebony with Cirrus	TP31	Ebony	Ebony	Ebony
	Ebony with Pimento	Ebony with Pimento	TP24	Ebony or Pimento <sup>4</sup>	Ebony	Ebony or Red
	Ebony with Reims Blue	Ebony with Reims Blue	TP32	Ebony	Ebony	Ebony
<b>Optional</b>						
Quilted Performance seats in premium leather with SVR embossed headrests and extended leather upper fascia <sup>2</sup>	Pimento with Ebony	Pimento with Ebony	TP23	Ebony or Pimento <sup>4</sup>	Ebony	Red
	Siena Tan with Cirrus	Siena Tan with Cirrus	TP34	Ebony	Ebony	Ebony

# 5 CHOOSE YOUR INTERIOR

 Configure your vehicle at [jaguar.com](http://jaguar.com)





Interior shown: F-TYPE R-Dynamic with optional Ebony premium leather Performance seats, Delta Aluminium finisher, Ebony morzine headlining, Ebony upper facia and Ebony carpets.

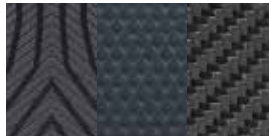
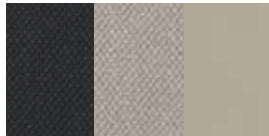

# F-TYPE AND F-TYPE R-DYNAMIC

## INTERIOR COLOUR COMBINATIONS

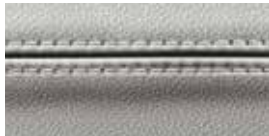
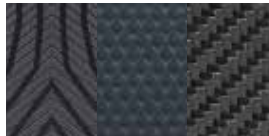
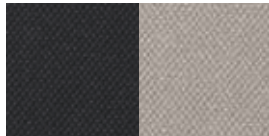
STANDARD SPORT SEATS WITH LEATHER AND SUEDECLOTH FACINGS  
 OPTIONAL SPORT SEATS IN PREMIUM LEATHER AND PREMIUM LEATHER INTERIOR

①	②	③	④	⑤
SEAT WITH STITCH	FINISHER	HEADLINING*	UPPER FACIA WITH STITCH	CARPET
				
Ebony with Ebony	Delta Aluminium <sup>†</sup> , Knurled Aluminium <sup>††</sup> , Carbon Fibre	Ebony, Grey or Ivory <sup>‡</sup>	Ebony with Ebony	Ebony
				
Cirrus with Cirrus	Delta Aluminium <sup>†</sup> , Knurled Aluminium <sup>††</sup> , Carbon Fibre	Ebony or Grey	Ebony with Ebony	Ebony

## OPTIONAL PERFORMANCE SEATS IN PREMIUM LEATHER AND PREMIUM LEATHER INTERIOR

SEAT WITH STITCH	FINISHER	HEADLINING*	UPPER FACIA WITH STITCH	CARPET
				
Ebony with Ebony	Delta Aluminium <sup>†</sup> , Knurled Aluminium <sup>††</sup> , Carbon Fibre	Ebony, Grey or Ivory <sup>‡</sup>	Ebony with Ebony	Ebony
				
Ebony with Pimento	Delta Aluminium <sup>†</sup> , Knurled Aluminium <sup>††</sup> , Carbon Fibre	Ebony, Grey or Pimento <sup>**</sup>	Ebony with Ebony	Ebony

\*Ebony morzine standard, Grey morzine and Ebony suedecloth optional. Ebony, Pimento and Ivory leather optional.

\*\*Pimento headlining available on Convertible only.

†Delta Aluminium is standard on F-TYPE R-Dynamic.











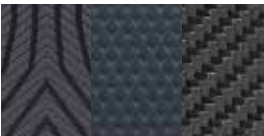
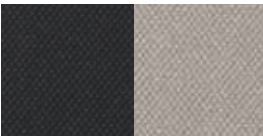



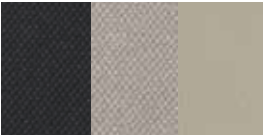

††Knurled Aluminium is standard on F-TYPE and optional on F-TYPE R-Dynamic.

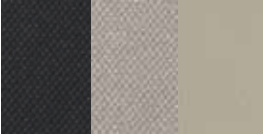
‡Ivory leather headlining not available with panoramic glass roof.

# F-TYPE AND F-TYPE R-DYNAMIC

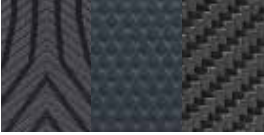
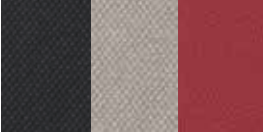
## INTERIOR COLOUR COMBINATIONS

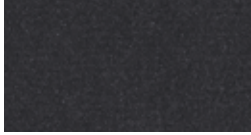
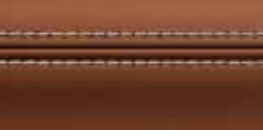
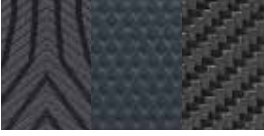
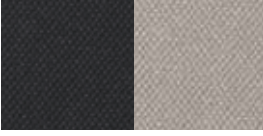
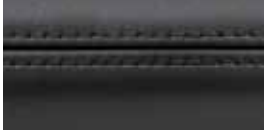
OPTIONAL PERFORMANCE SEATS IN PREMIUM LEATHER AND PREMIUM LEATHER INTERIOR [CONTINUED]

1	2	3	4	5
SEAT WITH STITCH	FINISHER	HEADLINING*	UPPER FACIA WITH STITCH	CARPET
 Ebony with Siena Tan	 Delta Aluminium+, Knurled Aluminium++, Carbon Fibre	 Ebony or Grey	 Ebony with Ebony	 Ebony
 Ebony with Ivory	 Delta Aluminium+, Knurled Aluminium++, Carbon Fibre	 Ebony, Grey or Ivory‡	 Ebony with Ebony	 Ebony
 Brogue with Ivory	 Delta Aluminium+, Knurled Aluminium++, Carbon Fibre	 Ebony, Grey or Ivory‡	 Ebony with Ebony	 Ebony
 Pimento with Ebony	 Delta Aluminium+, Knurled Aluminium++, Carbon Fibre	 Ebony, Grey or Pimento**	 Ebony with Ebony	 Ebony
 Siena Tan with Cirrus	 Delta Aluminium+, Knurled Aluminium++, Carbon Fibre	 Ebony or Grey	 Ebony with Ebony	 Ebony

\*Ebony morzine standard, Grey morzine and Ebony suedecloth optional. Ebony, Pimento and Ivory leather optional.



\*\*Pimento headlining available on Convertible only.

‡Delta Aluminium is standard on F-TYPE R-Dynamic.

††Knurled Aluminium is standard on F-TYPE and optional on F-TYPE R-Dynamic.

‡Ivory leather headlining not available with panoramic glass roof.







OPTIONAL PERFORMANCE SEATS IN PREMIUM LEATHER AND PREMIUM LEATHER INTERIOR [CONTINUED]

①	②	③	④	⑤
SEAT WITH STITCH	FINISHER	HEADLINING*	UPPER FACIA WITH STITCH	CARPET
				
Ivory with Ebony	Delta Aluminium <sup>+</sup> , Knurled Aluminium <sup>++</sup> , Carbon Fibre	Ebony, Grey or Ivory <sup>+</sup>	Ebony with Ebony	Ebony

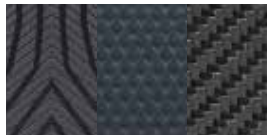
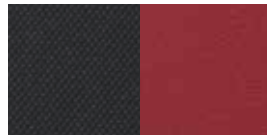
OPTIONAL PERFORMANCE SEATS IN PREMIUM LEATHER AND SUEDECLOTH AND PREMIUM LEATHER INTERIOR

SEAT WITH STITCH	FINISHER	HEADLINING	UPPER FACIA WITH STITCH	CARPET
				
Ebony with Cirrus	Delta Aluminium <sup>+</sup> , Knurled Aluminium <sup>++</sup> , Carbon Fibre	Ebony suedecloth	Ebony with Cirrus	Ebony

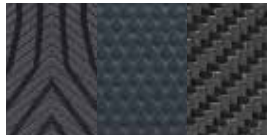
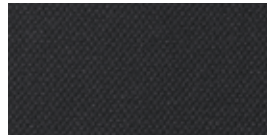
OPTIONAL PERFORMANCE SEATS IN PREMIUM LEATHER AND EXTENDED PREMIUM LEATHER INTERIOR

SEAT WITH STITCH	FINISHER	HEADLINING*	UPPER FACIA WITH STITCH	CARPET
				
Pimento with Ebony	Delta Aluminium <sup>+</sup> , Knurled Aluminium <sup>++</sup> , Carbon Fibre	Ebony or Pimento <sup>**</sup>	Pimento with Ebony	Ebony
				
Siena Tan with Cirrus	Delta Aluminium <sup>+</sup> , Knurled Aluminium <sup>++</sup> , Carbon Fibre	Ebony	Siena Tan with Cirrus	Ebony

# 5 CHOOSE YOUR INTERIOR

⚙️ Configure your vehicle at [jaguar.com](http://jaguar.com)









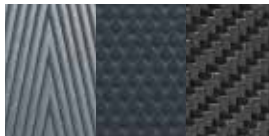
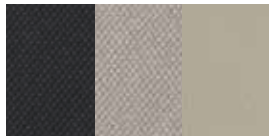

Interior shown: Optional Pimento premium leather Performance seats with Linear Vee Aluminium finisher, Ebony leather headlining, Pimento upper facia and Ebony carpets.

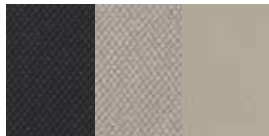
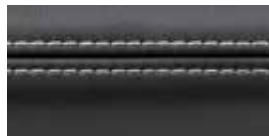

# F-TYPE R

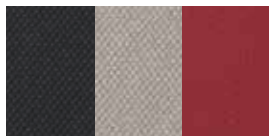
## INTERIOR COLOUR COMBINATIONS

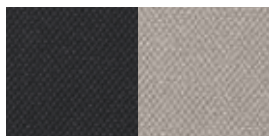
STANDARD R-PERFORMANCE SEATS IN PREMIUM LEATHER AND PREMIUM LEATHER INTERIOR

1	2	3	4	5		
SEAT WITH STITCH	FINISHER	HEADLINING*	UPPER FACIA WITH STITCH	CARPET		
 Ebony with Ebony	 Linear Vee Aluminium†, Knurled Aluminium, Carbon Fibre	 Ebony, Grey or Ivory**	 Ebony with Ebony	 Ebony		
 Ebony with Ivory					 Ebony, Grey or Ivory**	 Ebony with Ivory
 Ebony with Pimento					 Ebony, Grey or Pimento**	 Ebony with Pimento
 Ebony with Siena Tan					 Ebony or Grey	 Ebony with Siena Tan

\*Ebony morzine standard. Grey morzine and Ebony suedecloth optional. Ebony, Pimento and Ivory leather optional.

\*\*Pimento headlining available on Convertible only.











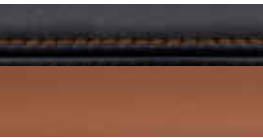

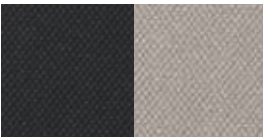
†Linear Vee Aluminium is standard.

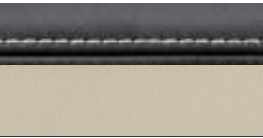
\*\*Ivory leather headlining not available with panoramic glass roof.

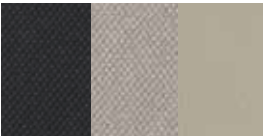
# F-TYPE R

## INTERIOR COLOUR COMBINATIONS

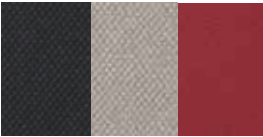
STANDARD R-PERFORMANCE SEATS IN PREMIUM LEATHER AND PREMIUM LEATHER INTERIOR [CONTINUED]

1	2	3	4	5
DUO TONE SEAT WITH STITCH	FINISHER	HEADLINING*	UPPER FACIA WITH STITCH	CARPET
				
Ebony with Siena Tan	Linear Vee Aluminium†, Knurled Aluminium, Carbon Fibre	Ebony or Grey	Ebony with Siena Tan	Ebony
				
Ebony with Ivory	Linear Vee Aluminium†, Knurled Aluminium, Carbon Fibre	Ebony, Grey or Ivory**	Ebony with Ivory	Ebony
				
Ebony with Pimento	Linear Vee Aluminium†, Knurled Aluminium, Carbon Fibre	Ebony, Grey or Pimento**	Ebony with Pimento	Ebony

\*Ebony morzine standard. Grey morzine and Ebony suedecloth optional. Ebony, Pimento and Ivory leather optional.

\*\*Pimento headlining available on Convertible only.

†Linear Vee Aluminium is standard.







\*\*Ivory leather headlining not available with panoramic glass roof.

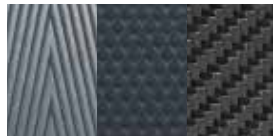
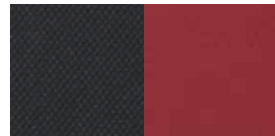

OPTIONAL R-PERFORMANCE SEATS IN PREMIUM LEATHER AND SUEDECLOTH AND PREMIUM LEATHER INTERIOR

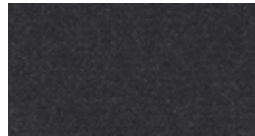
1	2	3	4	5
SEAT WITH STITCH	FINISHER	HEADLINING	UPPER FACIA WITH STITCH	CARPET
				
Ebony with Cirrus	Linear Vee Aluminium*, Knurled Aluminium, Carbon Fibre	Ebony suedecloth	Ebony with Cirrus	Ebony

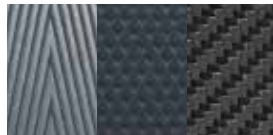
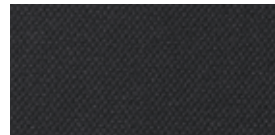
OPTIONAL R-PERFORMANCE SEATS IN PREMIUM LEATHER AND EXTENDED PREMIUM LEATHER INTERIOR

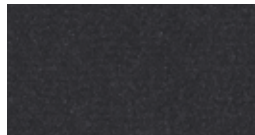
SEAT WITH STITCH	FINISHER	HEADLINING*	UPPER FACIA WITH STITCH	CARPET
				
Pimento with Ebony	Linear Vee Aluminium*, Knurled Aluminium, Carbon Fibre	Ebony or Pimento**	Pimento with Ebony	Ebony
				
Siena Tan with Cirrus	Linear Vee Aluminium†, Knurled Aluminium††, Carbon Fibre	Ebony	Siena Tan with Cirrus	Ebony

# 5 CHOOSE YOUR INTERIOR

Configure your vehicle at [jaguar.com](http://jaguar.com)











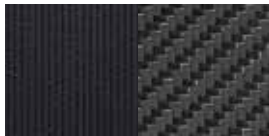

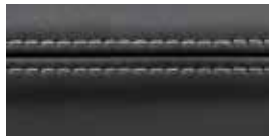
Interior shown: Ebony quilted premium leather Performance seats with Cirrus stitch and micropiping, Dark Brushed Aluminium finisher, Ebony headlining, Ebony upper fascia and Ebony carpets.

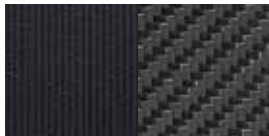



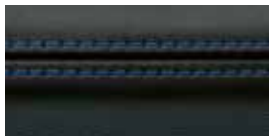
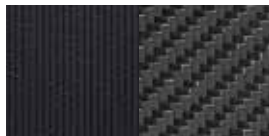



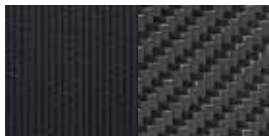

# F-TYPE SVR

## INTERIOR COLOUR COMBINATIONS

STANDARD SVR QUILTED PREMIUM LEATHER PERFORMANCE SEATS WITH PREMIUM LEATHER AND SUEDECLOTH INTERIOR

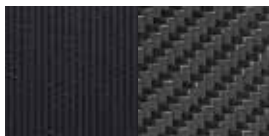
1	2	3	4	5
SEAT WITH STITCH	FINISHER	HEADLINING*	UPPER FACIA WITH STITCH	CARPET
				
Ebony with Cirrus	Dark Brushed Aluminium† or Carbon Fibre	Ebony	Ebony with Cirrus	Ebony
				
Ebony with Pimento	Dark Brushed Aluminium† or Carbon Fibre	Ebony or Pimento**	Ebony with Pimento	Ebony
				
Ebony with Reims Blue	Dark Brushed Aluminium† or Carbon Fibre	Ebony	Ebony with Reims Blue	Ebony

## OPTIONAL SVR QUILTED PREMIUM LEATHER PERFORMANCE SEATS WITH PREMIUM LEATHER INTERIOR

SEAT WITH STITCH	FINISHER	HEADLINING*	UPPER FACIA WITH STITCH	CARPET
				
Pimento with Ebony	Dark Brushed Aluminium† or Carbon Fibre	Ebony or Pimento**	Pimento with Ebony	Ebony
				
Siena Tan with Cirrus	Dark Brushed Aluminium† or Carbon Fibre	Ebony	Siena Tan with Cirrus	Ebony

\*Ebony suedecloth standard. Ebony and Pimento leather optional.

\*\*Pimento leather headlining only available on Convertible.

†Dark Brushed Aluminium is standard.

# 5 CHOOSE YOUR INTERIOR

 Configure your vehicle at [jaguar.com](https://www.jaguar.com)

Knurled Aluminium Centre Console

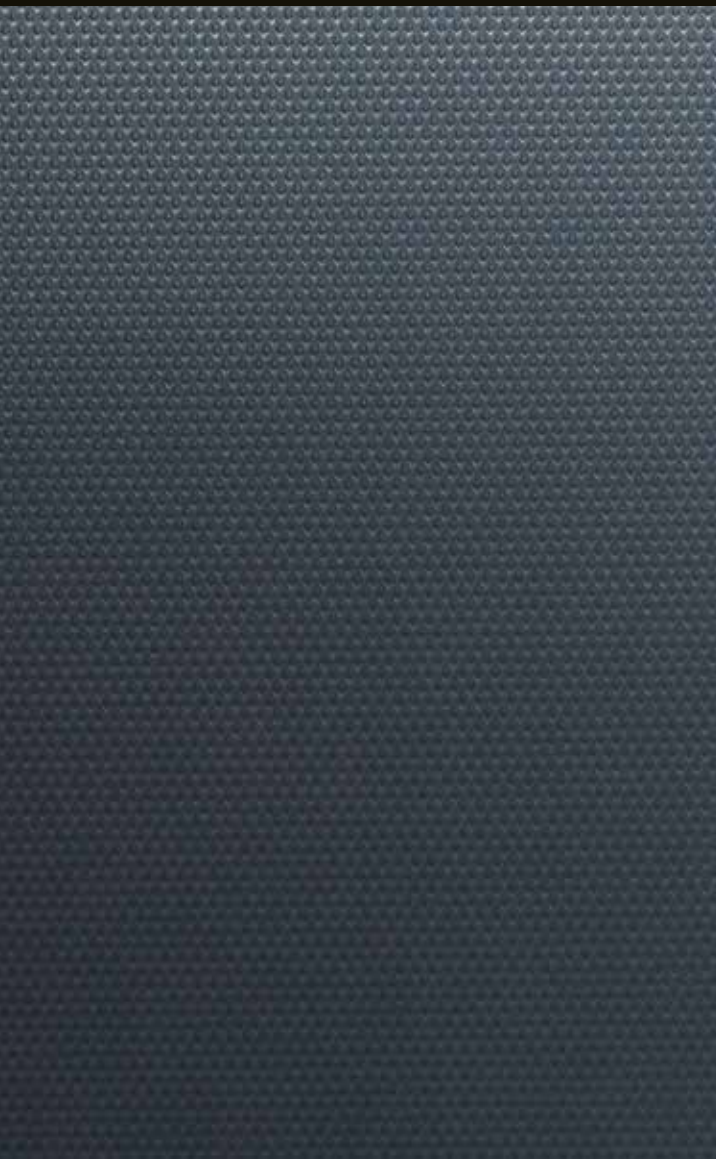

Delta Aluminium Centre Console

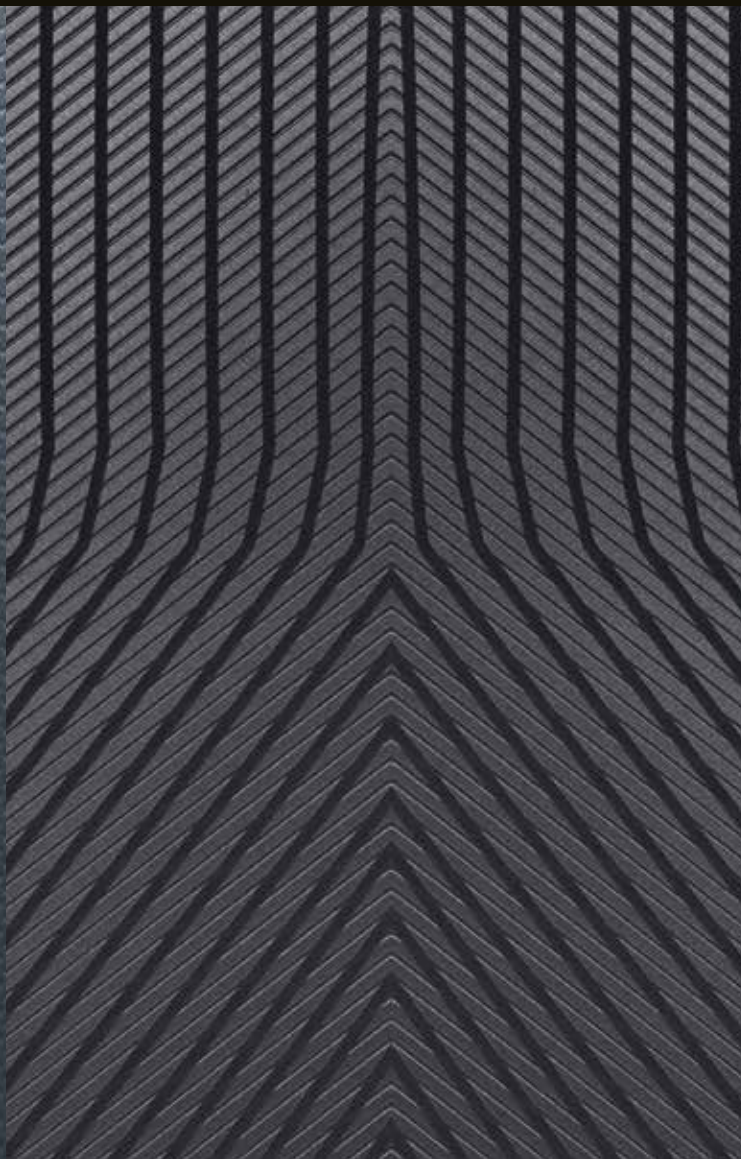

Linear Vee Aluminium Centre Console with R Branding



Carbon Fibre Centre Console

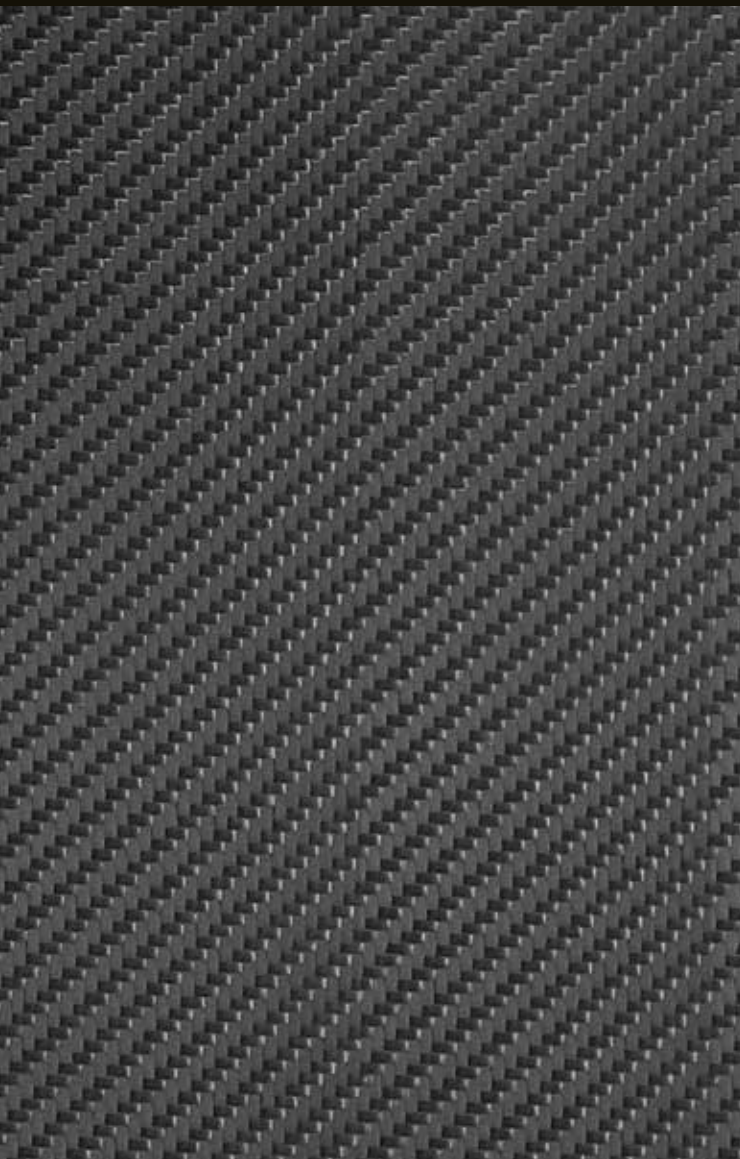

Dark Brushed Aluminium Centre Console with SVR Branding



Carbon Fibre Centre Console with SVR Branding

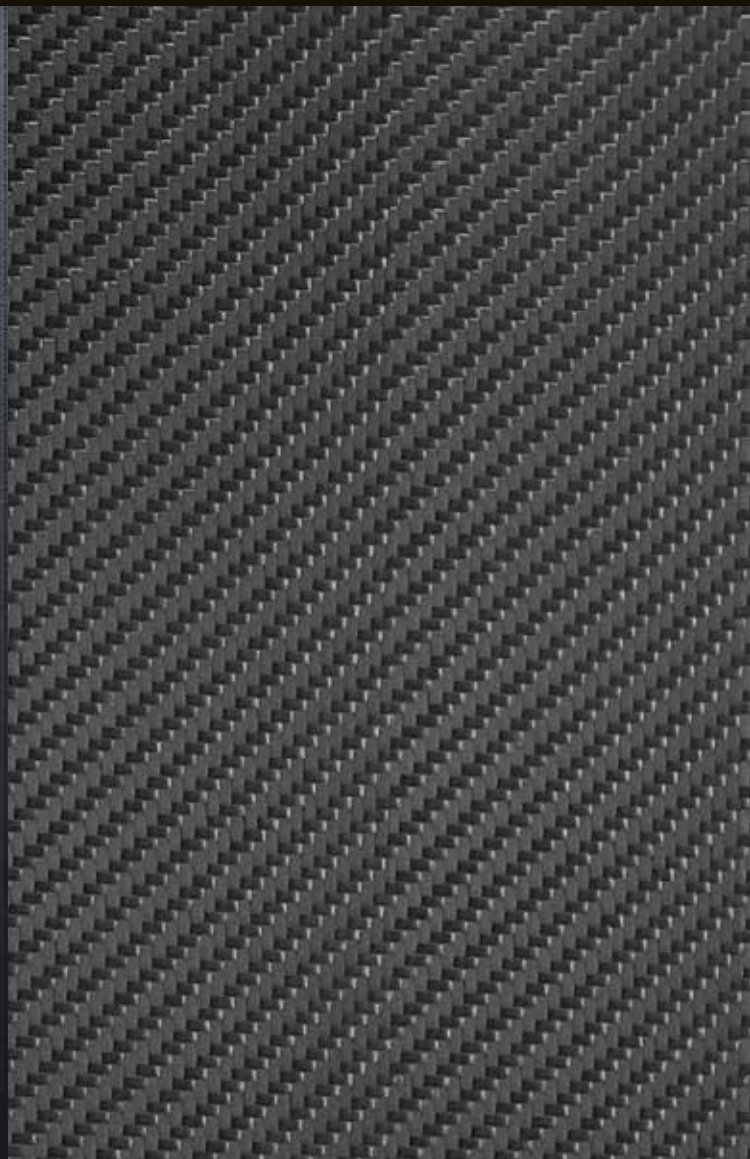

# 6 CHOOSE YOUR JAGUAR GEAR ACCESSORIES

To find out more about the full range of retailer fit Jaguar Gear Accessories, please refer to your retailer or go to [accessories.jaguar.com](https://accessories.jaguar.com)



VEHICLE SHOWN: F-TYPE R IN YULONG WHITE  
WITH SILVER WEAVE CARBON FIBRE PACK

\*Manual transmission only.  
\*\*Automatic transmission only.  
†Coupé only.



**Carbon Fibre Gear Selector\***  
**T2R24247**

Enjoy the unique feel of this performance-inspired Carbon Fibre topped gear selector with a High Gloss lacquered finish.



**Personalised Illuminated Sill Treadplates**  
**T2R6091**

Elegantly styled stainless steel sill treadplate finisher for driver or passenger doors. Illuminate when either the driver or passenger doors are opened. Highlighted by soft Phosphor Blue lighting. Allows you to specify a monochrome 'motif' in a choice of approved typefaces/scripts.



**Aluminium Gearshift Paddles\*\***  
**T2R6547MMU**

Replacement steering wheel gearshift paddles offered in a premium aluminium material providing a high quality finish to a key contact point in the vehicle. Manufactured from billet machined aluminium, the paddles are hand brushed for a premium finish and anodised to ensure they will not deteriorate with wear.



**Flexible Luggage Retainer**  
**C2D20903**

Provides a neat stowage solution to help secure luggage or other items within the luggage compartment.



**Luxury Carpet Mats**  
**T2R16570PVJ - Left Hand Drive**  
**T2R16571PVJ - Right Hand Drive**

Luxurious, tailored 2,050g/m<sup>2</sup> pile front carpet mats with embossed Jaguar logo and Nubuck edge binding. The luxury mats provide a well appointed finishing touch to the interior.



**Side Net†**  
**T2R22934**

Side net provides additional enclosed storage in the luggage compartment and helps to secure loose items such as bags or small parcels.

# 6 CHOOSE YOUR JAGUAR GEAR ACCESSORIES

 Configure your vehicle at [jaguar.com](http://jaguar.com)



**Silver Weave Carbon Fibre Side Power Vents\***  
T2R25198 - Left Side T2R25197 - Right Side

High-grade Silver Weave Carbon Fibre side power vents provide a performance-inspired styling enhancement. Featuring a 2x2 twill weave with an eye-catching aluminium thread and a High Gloss lacquered finish.



**Silver Weave Carbon Fibre Bonnet Louvres**  
T2R25193 - Left Side RWD T2R25191 - Right Side RWD  
T2R25194 - Left Side AWD T2R25192 - Right Side AWD

High-grade Silver Weave Carbon Fibre bonnet louvres featuring a 2x2 twill weave with aluminium thread and a High Gloss lacquered finish. Provides an eye-catching, performance-inspired styling enhancement coupled with the weight-saving benefits associated with carbon fibre.



**Silver Weave Carbon Fibre Mirror Covers**  
T2R25196 - Left Side T2R25195 - Right Side

High-grade Silver Weave Carbon Fibre mirror covers provide a performance-inspired styling enhancement. Featuring a 2x2 twill weave with an eye-catching aluminium thread and a High Gloss lacquered finish.



**Silver Weave Carbon Fibre Roll Hoops\*\***  
T2R23379 - Left Side T2R23378 - Right Side

High-grade Silver Weave Carbon Fibre roll hoops featuring a 2x2 twill weave with aluminium thread and a High Gloss lacquered finish. Provides an eye-catching, performance-inspired styling enhancement coupled with the weight-saving benefits associated with carbon fibre.



**Wind Deflector†**  
T2R11321

Simple to fit and remove, the wind deflector reduces air draught and turbulence in the passenger compartment, even at high speeds. Supplied with a Jaguar branded stowage bag.



**Gloss Black Side Power Vents\***  
T2R5996 - Left Side T2R5995 - Right Side

Jaguar branded Gloss Black side power vents provide a dynamic exterior styling enhancement.





**Chrome Bonnet Louvres\*\***  
**T2R5277LML - Left Side T2R5276LML - Right Side**

Bright finish accents highlight the F-TYPE exterior styling cues.



**Chrome Mirror Covers**  
**T2R5399 - Left Side T2R5400 - Right Side**

Chrome mirror covers accentuate the stylish design of the exterior mirrors.



**Chrome Roll Hoops\*\***  
**T2R5402 - Left Side T2R5401 - Right Side**

Bright finish accents highlight the F-TYPE exterior styling cues.



**All-Weather Car Cover**  
**T2R4364**

All-weather tailored cover for the F-TYPE with the Jaguar logo. Protect your F-TYPE from the elements, including showers, frost and dust. Quick and easy to fit.

\*N/A with F-TYPE SVR.

\*\*Available for F-TYPE Convertible only.

\*Standard on F-TYPE R and F-TYPE SVR. Also available as a line fit option.

\*\*Not applicable for AWD models.



**Rear Mounted Ski Carrier**  
**T2R13769 - V6 T2R11987 - V8**

Carrying up to two pairs of skis of up to 1.9m in length, this lockable carrier has been designed to ensure skis remain at ambient temperature in transit with minimal wind noise and resistance. Mounting mechanism has been positioned discreetly beneath the rear bumper ensuring a clean finish when the carrier mounting arms are removed. Following initial retailer installation the carrier can be removed easily in a matter of minutes.



**Gloss Black Grille**  
**T2R13838 - Without Parking Aids**  
**T2R13839 - With Parking Aids**

Provides a High Gloss Black finish to the grille surround and bumper beam accentuating the F-TYPE's dynamic appearance.

# TECHNICAL SPECIFICATIONS

 Configure your vehicle at [jaguar.com](http://jaguar.com)

ENGINES		F-TYPE AND F-TYPE R-DYNAMIC JAGUAR 3.0 LITRE V6 340 SUPERCHARGED PETROL				F-TYPE AND F-TYPE R-DYNAMIC JAGUAR 3.0 LITRE V6 380 SUPERCHARGED PETROL			
Cylinders/Valves per Cylinder		6/4				6/4			
Bore/Stroke	mm	84.5/89				84.5/89			
Capacity	cc	2,995				2,995			
Maximum power	EEC-PS (kW)	340 (250)				380 (280)			
@rev/min		6,500				6,500			
Maximum torque	EEC-Nm (lb.ft.)	450 (332)				460 (339)			
@rev/min		3,500 - 5,000				3,500 - 5,500			
Compression	ratio:1	10.5				10.5			
PERFORMANCE		COUPÉ		CONVERTIBLE		COUPÉ		CONVERTIBLE	
		MANUAL	AUTOMATIC	MANUAL	AUTOMATIC	MANUAL	AUTOMATIC	MANUAL	AUTOMATIC
0-100 km/h	seconds	5.7	5.3	5.7	5.3	5.5	4.9	5.5	4.9
0-60 mph	seconds	5.5	5.1	5.5	5.1	5.3	4.8	5.3	4.8
80-120 km/h (manual in 5 <sup>th</sup> gear)	seconds	7.2	3.3	7.2	3.3	7.2	3.1	7.2	3.1
50-75 mph (manual in 5 <sup>th</sup> gear)	seconds	7.2	3.3	7.2	3.3	7.2	3.1	7.2	3.1
Top speed	km/h (mph)	260 (161)	260 (161)	260 (161)	260 (161)	275 (171)	275 (171)	275 (171)	275 (171)
FUEL CONSUMPTION <sup>1</sup>		MANUAL	AUTOMATIC	MANUAL	AUTOMATIC	MANUAL	AUTOMATIC	MANUAL	AUTOMATIC
Urban	l/100km (mpg)	13.5 (20.9)	11.7 (24.1)	13.5 (20.9)	11.7 (24.1)	13.5 (20.9)	12.0 (23.5)	13.5 (20.9)	12.0 (23.5)
Extra Urban	l/100km (mpg)	7.6 (37.2)	6.5 (43.5)	7.6 (37.2)	6.5 (43.5)	7.6 (37.2)	6.6 (42.8)	7.6 (37.2)	6.6 (42.8)
Combined	l/100km (mpg)	9.8 (28.8)	8.4 (33.6)	9.8 (28.8)	8.4 (33.6)	9.8 (28.8)	8.6 (32.9)	9.8 (28.8)	8.6 (32.9)
CO <sub>2</sub> Urban	g/km	322	278	322	278	322	285	322	285
CO <sub>2</sub> Extra Urban	g/km	181	155	181	155	181	158	181	158
CO <sub>2</sub> Combined	g/km	234	199	234	199	234	203	234	203
Tank capacity (usable)	ltr (gals) approx.	70.0 (15.4)	70.0 (15.4)	70.0 (15.4)	70.0 (15.4)	70.0 (15.4)	70.0 (15.4)	70.0 (15.4)	70.0 (15.4)
DIMENSIONS		COUPÉ		CONVERTIBLE		COUPÉ		CONVERTIBLE	
Overall length	mm	4,482		4,482		4,482		4,482	
Overall width (inc. mirrors)	mm	2,042		2,042		2,042		2,042	
Overall width (with mirrors folded)	mm	1,923		1,923		1,923		1,923	
Overall height	mm	1,311		1,308		1,311		1,308	
Wheelbase	mm	2,622		2,622		2,622		2,622	
Front track	mm	1,597*		1,597*		1,597*		1,597*	
Rear track	mm	1,649**		1,649**		1,649**		1,649**	
Ground clearance	mm	101		101		101		101	
Turning circle diameter (kerb-to-kerb)	m (ft.in.)	10.7 (35.0)		10.7 (35.0)		10.7 (35.0)		10.7 (35.0)	
Convertible boot volume	litres (cu.ft.)	—		207 (7.3)		—		207 (7.3)	
Coupé boot volume with parcel tray	litres (cu.ft.)	310 (10.9)		—		310 (10.9)		—	
Coupé boot volume without parcel tray	litres (cu.ft.)	408 (14.4)		—		408 (14.4)		—	
WEIGHT <sup>2</sup>		MANUAL	AUTOMATIC	MANUAL	AUTOMATIC	MANUAL	AUTOMATIC	MANUAL	AUTOMATIC
Weight from	kg	1,567	1,577	1,587	1,597	1,584	1,594	1,604	1,614
Gross vehicle weight	kg	2,000	2,000	2,000	2,000	2,050	2,050	2,050	2,050

\*1,585 on 20" wheels. \*\*1,627 on 20" wheels.

<sup>1</sup>Official EU test figures. For comparison purposes only. Real world figures may differ. These figures are correct at time of going to press. <sup>2</sup>Please consult your local Jaguar Retailer for details of charges associated with option fitment. Weights reflect vehicles to standard specifications. Optional extras increase weight.

F-TYPE AND F-TYPE R-DYNAMIC JAGUAR 3.0 LITRE V6 380 SUPERCHARGED PETROL AWD		F-TYPE R JAGUAR 5.0 LITRE V8 550 SUPERCHARGED PETROL AWD		F-TYPE SVR JAGUAR 5.0 LITRE V8 575 SUPERCHARGED PETROL AWD	
6/4		8/4		8/4	
84.5/89		92.5/93		92.5/93	
2,995		5,000		5,000	
380 (280)		550 (405)		575 (423)	
6,500		6,500		6,500	
460 (339)		680 (502)		700 (516)	
3,500 - 5,500		3,500		3,500	
10.5		9.5		9.5	
COUPÉ AUTOMATIC	CONVERTIBLE AUTOMATIC	COUPÉ AUTOMATIC	CONVERTIBLE AUTOMATIC	COUPÉ AUTOMATIC	CONVERTIBLE AUTOMATIC
5.1	5.1	4.1	4.1	3.7	3.7
4.9	4.9	3.9	3.9	3.5	3.5
3.3	3.3	2.5	2.5	2.3	2.3
3.3	3.3	2.5	2.5	2.3	2.3
275 (171)	275 (171)	300 (186)	300 (186)	322 (200)	314 (195)
COUPÉ	CONVERTIBLE	COUPÉ	CONVERTIBLE	COUPÉ	CONVERTIBLE
12.4 (22.8)	12.4 (22.8)	16.2 (17.4)	16.2 (17.4)	16.2 (17.4)	16.2 (17.4)
6.9 (40.9)	6.9 (40.9)	8.5 (33.2)	8.5 (33.2)	8.5 (33.2)	8.5 (33.2)
8.9 (31.7)	8.9 (31.7)	11.3 (25.0)	11.3 (25.0)	11.3 (25.0)	11.3 (25.0)
295	295	386	386	386	386
165	165	203	203	203	203
211	211	269	269	269	269
70.0 (15.4)	70.0 (15.4)	70.0 (15.4)	70.0 (15.4)	70.0 (15.4)	70.0 (15.4)
COUPÉ	CONVERTIBLE	COUPÉ	CONVERTIBLE	COUPÉ	CONVERTIBLE
4,482	4,482	4,482	4,482	4,482	4,482
2,042	2,042	2,042	2,042	2,042	2,042
1,923	1,923	1,923	1,923	1,923	1,923
1,311	1,308	1,311	1,308	1,311	1,308
2,622	2,622	2,622	2,622	2,622	2,622
1,597*	1,597*	1,585	1,585	1,585	1,585
1,649**	1,649**	1,627	1,627	1,611	1,611
104	104	100	100	107	107
11.3 (37.0)	11.3 (37.0)	11.3 (37.0)	11.3 (37.0)	11.3 (37.0)	11.3 (37.0)
—	207 (7.3)	—	207 (7.3)	—	207 (7.3)
310 (10.9)	—	310 (10.9)	—	310 (10.9)	—
408 (14.4)	—	408 (14.4)	—	408 (14.4)	—
COUPÉ	CONVERTIBLE	COUPÉ	CONVERTIBLE	COUPÉ	CONVERTIBLE
1,674	1,694	1,730	1,745	1,705	1,720
2,150	2,150	2,150	2,150	2,150	2,150

# DIMENSIONS

Dimensions shown are based upon F-TYPE R, Coupé and Convertible. For details of all derivatives please refer to the Technical Specifications on page 106 and 107.

**Overall Width** (inc mirrors) 2,042mm

**Overall Width** (mirrors folded) 1,923mm

**Boot Volume** 408 litres (Coupé) 207 litres (Convertible)



**Turning Circle**  
Kerb-to-kerb  
10.7m (RWD)  
11.3m (AWD)



Dimensions were measured with vehicle at unladen weight. (Measured by VDA standard test method using 200 x 100 x 50mm blocks).  
Figures shown are for F-TYPE R. See pages 106-107 for full details on Technical Specifications.  
VEHICLE SHOWN F-TYPE R IN YULONG WHITE WITH OPTIONAL FEATURES FITTED (MARKET DEPENDENT)

## JAGUAR EXPERIENCE

There's no better way to get to know Jaguar than by taking a drive. The Jaguar Experience offers a range of unique opportunities to really find out what it feels like to get the most out of a Jaguar. Our track experiences allow you to push yourself and cars from the incredible Jaguar range to the limit. Jaguar Experience also offers the opportunity to see a Jaguar brought to life during a tour of one of our UK manufacturing facilities.

Find out more by visiting [jaguar.com/experience](http://jaguar.com/experience)



## BEHIND THE SCENES

Our factory tours give you the unique opportunity to experience the whole process of how our cars are brought to life - from the moulding of sheet metal to those intricate final touches. At our state-of-the-art production facilities, you'll get to see how skilled technicians and sophisticated machines work seamlessly together to perfect some of Jaguar's most breathtaking cars.

Find out more at [jaguar.com/experience-jaguar/behind-the-scenes](http://jaguar.com/experience-jaguar/behind-the-scenes)



## DRIVING EXPERIENCES

The opportunity to drive the latest Jaguar cars at their limits, or relive iconic Jaguar history, is rare. Jaguar Driving Experiences offer unique driving adventures you will never forget. Imagine yourself behind the wheel of our highest performing Jaguar models, on a private track, with a Jaguar Experience Instructor at your side. This is the Jaguar Performance Driving Academy.

Find out more at [jaguar.com/experience-jaguar/driving-experiences](http://jaguar.com/experience-jaguar/driving-experiences)



## ICONIC EXPERIENCES

Take your driving to the next level with the Jaguar Land Rover Ice Drive Experience. From 2017, we are offering an adventure in Arjeplog, Sweden, that will test and develop your performance driving skills in extreme conditions. It's a rare chance for owners and enthusiasts to tackle some of the harshest and most challenging tracks on earth, under the skilled guidance of our experts. Our driving instructors are of the highest-calibre and will be with you every step of the way - ready to impart years of driving wisdom. You will dance on ice, glide around some of the most awe-inspiring corners imaginable and realise the true exhilarating potential of Jaguar and Land Rover.

If you'd like to be part of the next adventure, find out more by visiting [jaguar.com/experience-jaguar/iconic-experiences](http://jaguar.com/experience-jaguar/iconic-experiences)

# THE WORLD OF JAGUAR

Choose an F-TYPE and you're joining the exciting World of Jaguar. It makes owning and driving carefree and easy, as well as providing a range of exclusive services and lifestyle products.



## JAGUAR CARE\*

F-TYPE is offered with an unlimited mileage, three year warranty and three years' servicing programme. We call this programme Jaguar Care. It makes F-TYPE's overall cost of ownership one of the lowest in its class.



## GENUINE PARTS

Jaguar Genuine Parts are designed, tested and manufactured to our uncompromising standards for quality, fit and durability. Each part is engineered specifically for your F-TYPE to contribute to optimum performance and to help maximise its lifespan.



## JAGUAR FINANCIAL SERVICES

Effortless performance and style come as standard with every Jaguar. Jaguar Financial Services makes buying one just as simple and rewarding. New or used, for personal or business use, we have an option that puts you in complete control. Please speak to your local Jaguar Retailer to find out more.

\*Available in selected European markets only.





#### JAGUAR ASSISTANCE

Jaguar Assistance provides assistance in motoring emergencies, all the way from immobilisation due to breakdown or accident to minor problems such as punctures. You can rely on our roadside assistance, whatever the situation, wherever you happen to be.



#### FLEET & BUSINESS

Jaguar is dedicated to being the premium manufacturer of choice for fleets and businesses by providing a highly attractive car range and exemplary customer service. Jaguars are dynamic and distinctive cars that help companies express the unique character and personality of their business. We are committed to providing totally customer-focused aftersales services, which keeps every Jaguar car on the move and in top condition, ensuring that they perform to the highest standard and in the most cost-efficient way for businesses. Visit [jaguar.com/fleet-and-business](http://jaguar.com/fleet-and-business) for more information.



#### JAGUAR MAGAZINE

This is our own vibrant, cosmopolitan and contemporary magazine. Produced by a team of enthusiastic designers and feature writers, it goes behind the scenes at Jaguar as well as providing insight into the world of luxury, design, style and travel. You can enjoy Jaguar Magazine twice a year completely free of charge for the first three years. Ask your retailer to ensure that you receive your copy.

#### JAGUAR COLLECTION

The latest Jaguar Collection has been crafted with the same design execution and attention to detail that goes into all of our cars. This is evident in our clothing range, premium leather items and luxury travel goods. To celebrate Jaguar's heritage we also have a collection that honours past achievements and features race inspired gift items and apparel. To find out more, visit the online shop at [www.jaguar.co.uk/shop](http://www.jaguar.co.uk/shop)

# GLOSSARY

## A

### ABS SYSTEM

This anti-lock braking system prevents wheel lock up under heavy braking to maintain vehicle control.

### ACTIVE SPORTS EXHAUST

This system features active valves that, when open, allow the exhaust gases to exit via a more direct route producing a richer, more exhilarating noise. The system also allows the driver to use a button on the centre console (if optioned) to manually activate the valves.

### AMBIENT INTERIOR MOOD LIGHTING

Ambient Interior Mood Lighting highlights many of the cabin's key features and design details in a relaxing soft Phosphor Blue glow (See page 38 on Mood Lighting).

### AUDYSSEY MULTEQ AUDIO EQUALISATION

Audyssey MultEQ Audio Equalisation digitally corrects any imperfections created by the cabin environment to deliver accurate, enveloping, and distortion-free sound for all seating positions.

## C

### CABIN CORRECTION ALGORITHM

Meridian's Cabin Correction Algorithm intelligently and discreetly optimises the audio system to the precise acoustics of the vehicle cabin, preserving the natural rhythm of the performance.

### CAE DEVELOPMENT PROCESS

Computer-Aided Engineering (CAE) is the usage of computer models and software to aid engineering analysis.

### COMBUSTION CHAMBER

A combustion chamber is the part of an engine where the fuel and air mixture is burned.

## D

### DIE-CAST ALUMINIUM BLOCKS

Die-casting is a metal casting process used to form the aluminium blocks for F-TYPE's engines. It involves forcing molten metal under high pressure into a mould. This allows for excellent dimensional accuracy and the casting of thinner walls.

### DSP AMPLIFIER

Meridian's Digital Signal Processing (DSP) technology analyses a range of variables that may impact audio quality, then processes them using sophisticated algorithms and adapts the system's output accordingly. This enables a level of powerful, authentic performance impossible with a conventional sound system.

### DUAL INDEPENDENT VARIABLE CAMSHAFT TIMING

Dual Independent Variable Camshaft Timing is a feature whereby the engine can adjust the timing of both the intake and exhaust valves independently. This allows for improved power and torque, particularly at lower engine revs, as well as improved fuel economy and reduced emissions.

### DAMPERS/DAMPING

Dampers absorb forces acting on the suspension for greater ride comfort and control. Dampers are also known as shock absorbers.

## F

### FORGED ALUMINIUM DOUBLE WISHBONE SUSPENSION

F-TYPE's front and rear double wishbone suspension is an independent suspension design using two wishbone-shaped arms to place the wheel. Double wishbone designs deliver precise handling and steering response.

## I

### INCONEL®

Inconel is a family of austenite nickel-chromium-based superalloys. Inconel alloys are oxidation and corrosion resistant materials well suited for service in extreme environments subjected to pressure and heat.

### INTELLIGENT STOP/START

Stop/Start is a technology that stops the engine when it is not needed, improving the fuel economy and reducing the car's CO<sub>2</sub> emissions. The engine will restart immediately as soon as the driver's foot comes off the brake pedal. The engine will be operating at full capacity before the driver's foot has touched the accelerator pedal.

## M

### MANUAL MODE

Manual Mode is a mode available on automatic transmissions that allows you to manually upshift and downshift.

### MERIDIAN TRIFIELD™ TECHNOLOGY

Meridian's exclusive Trifield™ technology, delivers a consistent, concert-like experience, optimised for all seating positions.

### MONOBLOC CALIPERS

Monobloc calipers are forged from one piece of metal. This makes them more resistant to flex under load, so they waste less energy and deliver consistent braking feel.

### MULTI-PLATE CLUTCH

A Multi-plate clutch uses several friction discs to transmit power from the engine to the transmission. This decreases drag and increases the amount of torque that is transmitted while minimising the amount of force needed to operate the clutch, enabling faster and smoother shifting.

## S

### SHORT-THROW GEAR LEVER

A short-throw gear lever has a reduced length to enable swifter gear changes.

### SUPERCHARGED PETROL

A petrol engine with a supercharger. A supercharger is a forced induction device mechanically driven by the engine. It offers higher power outputs and immediate, linear response at all engine speeds.

## X

### XENON HEADLIGHTS

Bi-function Xenon headlights offer improved illumination and feature LED 'J' blade Daytime Running Lights for a striking on-road style.



#### IMPORTANT NOTICE

Jaguar Land Rover Limited is constantly seeking ways to improve the specification, design and production of its vehicles and alterations take place continually. While every effort is made to produce up-to-date literature, this brochure should not be regarded as an infallible guide to current specifications, nor does it constitute an offer for the sale of any particular vehicle. Distributors and Retailers are not agents of Jaguar Land Rover Limited by any express or implied undertaking or representation. Comparisons are based on manufacturer's own data and testing prior to publication.

#### COLOURS

Print and online colours are representative only.

#### ENVIRONMENTAL INNOVATION AT JAGUAR

Jaguar is committed to reducing dependency on fossil fuels, using fewer natural resources and creating less waste as part of our approach to responsible and sustainable business development, called Environmental Innovation.

Our innovative use of lightweight aluminium (featured in the F-TYPE, F-PACE, XJ, XE and XF) is helping to improve fuel consumption and lower tailpipe CO<sub>2</sub> emissions, as well as delivering other handling and performance benefits to these vehicles.

At the same time, our smart management of resources enables scrap aluminium reclaimed from our stamping process to be segregated and recycled to create the same quality of aluminium sheet with up to 50% recycled content. Compared to using virgin aluminium, this closed-loop recycling system also reduces CO<sub>2</sub> emissions during the manufacturing process.

As a whole, Jaguar Land Rover has reduced its European fleet average tailpipe emissions by 25% versus 2007 and operational CO<sub>2</sub> emissions per vehicle by 30.5%\*. Our manufacturing facilities are all certified to ISO14001 and we have cut the amount of manufacturing waste to landfill per vehicle by 75%\* and reduced our water consumption per vehicle by 34%\*. (\*versus 2007) As part of our journey to Carbon Neutral Manufacturing by 2020, we offset 100% of (currently unavoidable) operational CO<sub>2</sub> emissions by investing in projects that reduce the equivalent amount of CO<sub>2</sub> emissions in other ways, providing social and humanitarian benefits at the same time. For example, our award winning Lifestraw 'Carbon for Water' emissions reduction project has prevented the release of 968,000 tonnes of CO<sub>2</sub> (since it began in 2013) and improved the lives of 2.4 million people in Kenya.

Taking into account the company's global sales growth and increased investment in more efficient operating facilities, we are proud of the progress we have made against our 2020 Environmental Innovation targets to date. Our achievements have also been recognised externally: In 2013 the Company was recognised as the UK's Responsible Business of the Year by leading CR index, Business in the Community and in 2014 we were awarded the Queen's Award for Enterprise in Sustainable Development.

Looking forward, we have developed a 2020 vision for sustainable business growth that focuses on continued improvements in operating & tailpipe CO<sub>2</sub> emissions, carbon neutral manufacturing and zero waste. Jaguar Land Rover also aims to improve the lives of 12 million people by 2020 as part of its global Corporate Social Responsibility programme.

Meridian is the registered trademark of Meridian Audio Ltd.

The Bluetooth® word mark and logos are owned by the Bluetooth SIG, Inc. and any use of such marks by Jaguar Land Rover Limited is under license.

iPhone is a trademark of Apple Inc., registered in the US and other countries.

The navigation system must always be used in conditions that will not affect the driver's ability to drive safely or affect the safety of other road users.

**VEHICLE SHOWN FRONT COVER: F-TYPE SVR IN CALDERA RED WITH OPTIONAL FEATURES FITTED (MARKET DEPENDENT)**  
**VEHICLE SHOWN BACK COVER: F-TYPE SVR IN CALDERA RED WITH OPTIONAL FEATURES FITTED (MARKET DEPENDENT)**

Jaguar Land Rover Limited  
Registered Office: Abbey Road, Whitley,  
Coventry, CV3 4LF, United Kingdom  
Registered in England Number: 1672070  
jaguar.com



October 2016/18MY  
JLM/24/02/12/1016

